

 **KENWOOD**

**V-LHF
ALL MODE DUAL BANDER**

Model TS-770



OPERATING MANUAL

You are the owner of our latest product, the new TS-770 Dual Band Transceiver.

This unit has been carefully engineered and manufactured to rigid quality standards, and should give you satisfactory and dependable operation for many years. Should any trouble arise with this unit, please contact your dealer, the nearest KENWOOD service facility, or the factory.

We suggest that you read this instruction manual carefully from cover to cover to insure the maximum performance and trouble-free operation of your new model TS-770.

Save the shipping boxes and packing in the event your unit needs to be transported for remote operation, maintenance, or service.

CONTENTS

SPECIFICATIONS	3
1. FEATURES	4
2. BEFORE USING	6
3. CONTROLS AND THEIR FUNCTIONS	7
4. PRELIMINARY	11
5. OPERATING INSTRUCTIONS	13
6. OPTIONAL ACCESSORIES	22
7. TROUBLESHOOTING	24
8. CIRCUIT ARRANGEMENT	25
BLOCK DIAGRAM	26
SCHEMATIC DIAGRAM	27
INTERNAL PARTS LOCATIONS	30

TS-770 SPECIFICATIONS (W Type)

N^o = 0051093

GENERAL

Frequency Range	144.0 ~ 146.0 MHz 430.0 ~ 440.0 MHz
Mode	SSB (USB, LSB), CW, FM
Voltage Requirements	220V AC, 50/60 Hz 12.0 ~ 16.0V DC (13.8V DC nominal)
Power Consumption	Receive (no signal): 45 watts (220V AC), 1.5A (13.8V DC) Transmit: 130 watts (220V AC), 6A (13.8V DC)
Semiconductor Complement	Transistors: 161 FETs: 31 ICs: 63 Diodes: 224
Dimensions	290 (W) × 124 (H) × 320 (D) mm (11 ³ / ₁₆) × (14 ⁷ / ₈) × (12 ⁵ / ₈)
Weight	11 kg (24.2 lbs)

TRANSMITTER SECTION

RF Power Output	SSB, CW, FM: 10 watts FM (LOW): Approx. 1 watt
Modulation	SSB: Balanced modulation FM: Variable reactance frequency shift
Maximum frequency deviation (FM)	±5 kHz
Carrier Suppression	Better than 40 dB
Unwanted Sideband Suppression	Better than 40 dB
Spurious Radiation	Better than -60 dB
Microphone Impedance	500 ~ 600Ω
Antenna Impedance	50Ω
AF Response of Transmitter (SSB)	400 ~ 2600 Hz (-9 dB)
RPT Tone Frequency	1750 Hz

RECEIVER SECTION

Receiver Sensitivity	SSB, CW: 0.25 μV for 10 dB (S+N)/N FM: 1 μV for 30 dB (S+N)/N 0.4 μV for 20 dB
Intermediate Frequency	1st: 21.6 MHz 2nd: 8.83 MHz (144 MHz FM 455 kHz)
Image Rejection	1st IF: Better than 60 dB 2nd IF: Better than 50 dB
IF Rejection	Better than 70 dB
Squelch Sensitivity	0.5 μV
Audio Output	2.5 watts (with less than 10% distortion) into an 4 ohm load
Receiver Selectivity	SSB, CW: 2.4 kHz (-6 dB) 4.8 kHz (-60 dB) FM: 12 kHz (-6 dB) 24 kHz (-60 dB)
Frequency Stability	Within ±1 kHz during the first hour after 1 minute of warmup Within 150 Hz during any 30 minute period after warmup.

The above specifications are subject to change without notice for improvement.

SECTION 1. FEATURES

1. 144/430 MHz, all mode (FM, SSB (USB, LSB), CW) transceiver.
 - Microprocessor controlled VFO and full variety of auxiliary functions.
 - FM circuitry based on KENWOOD's advanced technology and outstanding SSB quality.
 - Built-in VOX.
 - Built-in side tone and CW circuitry capable of semi-break-in operation.
 - Easy-to-operate 1 band, 1 MHz VFO stops at 999.98 kHz or is continuously adjustable (endless system).
2. Built-in digital display that indicates operating frequency in all modes.
 - Digital display equipped with easy-to-read green phosphor tubes.
 - 7-digit digital display that directly reads down to 100 Hz.
 - Frequency indicator that reads out carrier positions when mode of operation is changed.
 - Indicates fixed channel (stores any given frequency) and call channel frequencies, besides VFO A and B frequencies.
 - Digital display indicates which VFO (A or B) is in use, fixed channel numbers (1 through 8).
 - The use of display select circuit turns off the 100 Hz digits in FM mode.
3. Dependable electrical and mechanical functions.
 - VFO frequencies are switchable in 2 speeds, SLOW (in 20 Hz steps) and FAST (in 200 Hz steps).
 - VFO knob equipped with variable torque mechanism.
 - Pushbutton band select switches (UP and DOWN) that shift up and shift down frequency between 144 MHz and 440 MHz in 12 bands at 1 MHz intervals.
 - Wide band design for both transmitter and receiver that eliminates the need for tuning the RF circuits.
 - Panel layout based on human engineering.
 - Full variety of indicating functions to check operating conditions (Pilot lamps: ON AIR, Hi/LOW (FM transmit), F-LOCK, RIT, SLOW/FAST, Back-up power ON/OFF).
 - Amplified type AGC and ALC circuits that maintain receive and transmit outputs at constant level without distortion.
4. A multitude of auxiliary functions for more enjoyable operation.
 - The use of RAM memory system microprocessor enables any given frequencies to be stored in or cleared from fixed channels (8 CH).
 - Built-in back-up power circuit to keep data stored at all times.
 - Built-in scan and search circuits.
 - RIT circuit functions on VFO, fixed channels and call channel.
 - Adoption of frequency lock circuit.
 - KENWOOD's unique noise blanker (NB) circuit to eliminate pulse type noise.
 - Equipped with two meters, one is an "S" meter (with RF/ALC selector) and the other is a center meter for use on FM.
 - RF power HIGH/LOW selecting function provides convenience in transmission with local stations.
 - Auxiliary (AUX) socket.
5. Designed for fixed and mobile station services.
 - AC/DC 2-way power operation.
 - Equipped with a grip for carrying convenience.
 - Sufficient AF output power (2.5W/4Ω).
 - Built-in large sized speaker (7.5 cm). External speaker connecting jack.

SECTION 2. BEFORE USING

2-1. ACCESSORIES

The following accessory items are included with the unit.

Operating manual.....	1 copy
Fuse 2A	1 piece
Foot (with screws)	2 pieces
Speaker plug.....	1 piece
DIN plug.....	1 piece
AC power cord	1 piece

2-2. OPERATING LOCATION

As with any solid state equipment, the TS-770 should be kept from extremes of heat and humidity. Choose an operating location that is dry and cool, and avoid operating the unit in direct sunlight.

2-2. CONNECTION OF MICROPHONE AND HEADPHONE

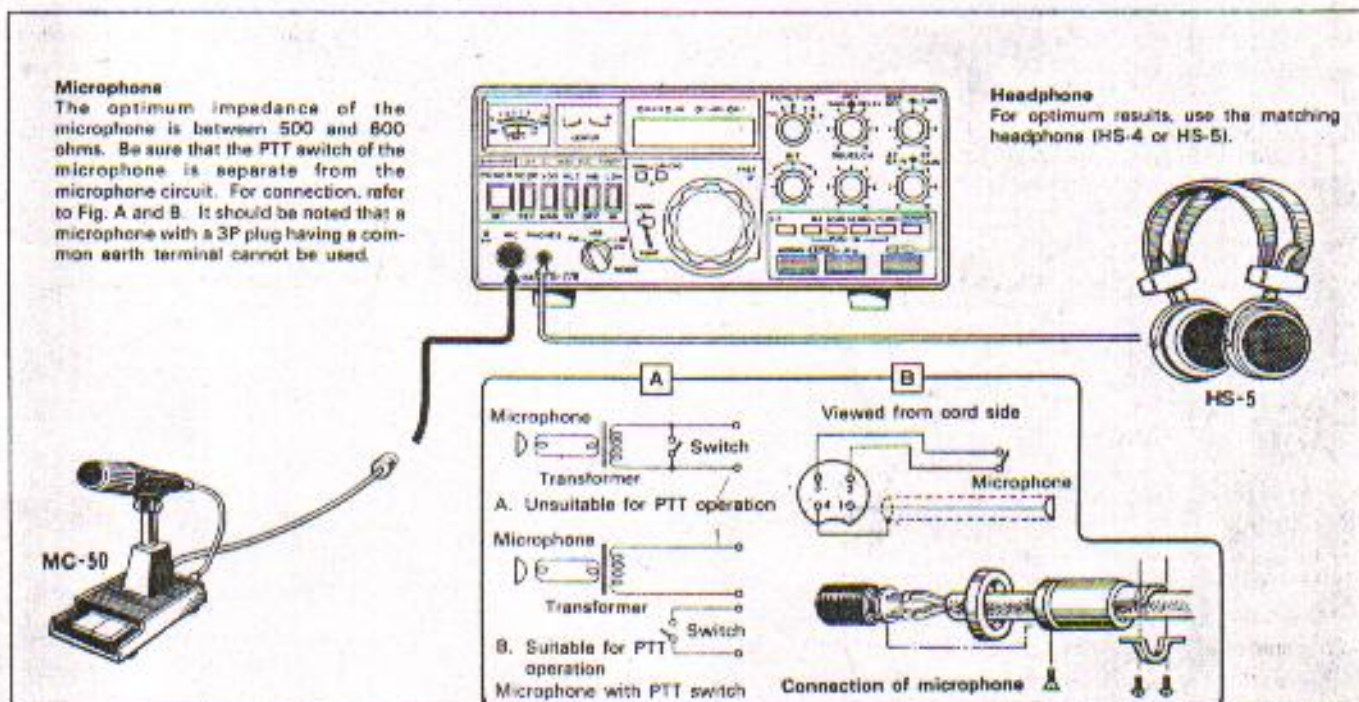
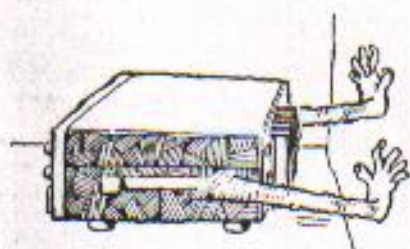

Fig. 1



The TS-770 has a heat sink on the rear panel. Be sure to install the unit so there is adequate clearance at the rear and bottom.



When you wish to use the unit in a car, be sure to provide heat dissipating clearance between the unit and the seat and to make proper provision against physical shock.

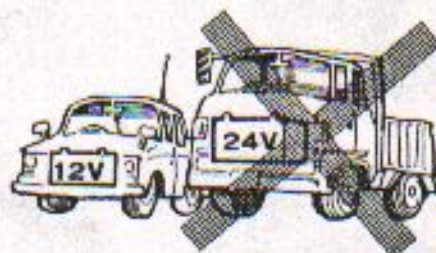

For mobile operation, connect the unit to a 12V car battery (6A). Do not connect it to a 24V battery.

2-3. CABLING FOR ANTENNA, POWER SUPPLY AND OTHERS

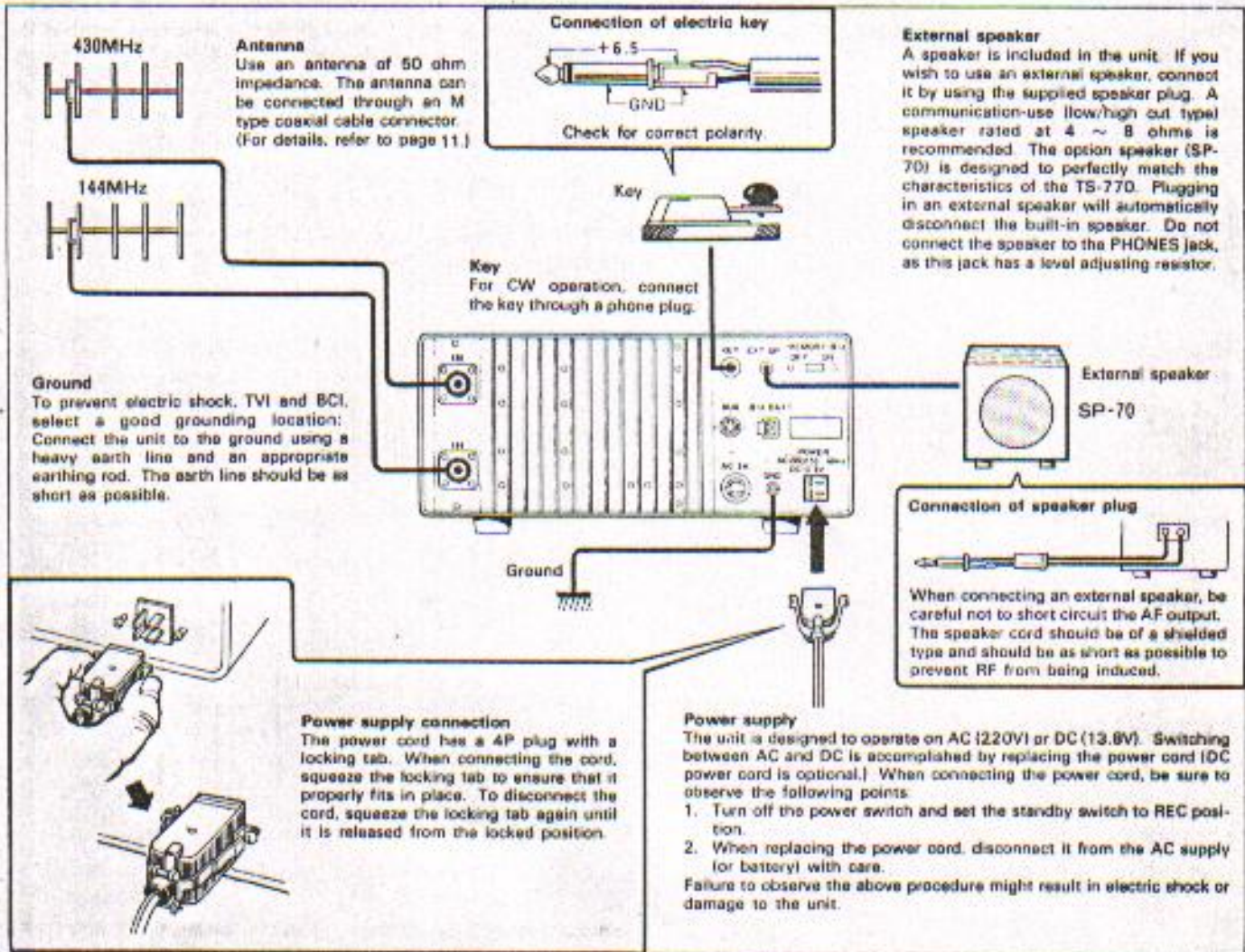
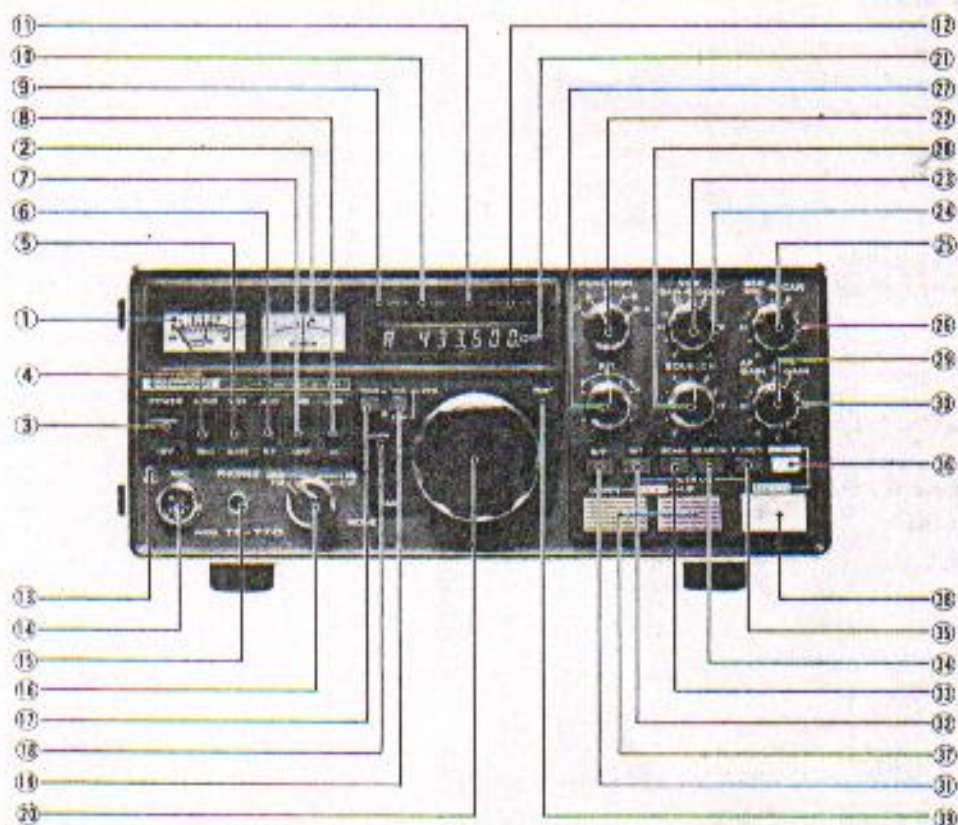

Fig. 2

SECTION 3. CONTROLS AND THEIR FUNCTIONS



3-1. FRONT PANEL

① METER (A)

This meter has three functions. During reception, it serves as an "S" meter indicating the strength of received signal on a scale graduated from 1 to 9, 9 + 20 dB and 9 + 40 dB. During Transmission, the meter indicates RF output. With the meter switch set to ALC position, the meter indicates the drive (input) voltage to the transmit power amplifier. In SSB operation, adjust the MIC gain control so that the meter pointer deflects within the ALC zone on the scale. In the ALC position, the meter functions as an "S" meter during reception.

② Meter (B)

This meter functions as a center meter during FM reception. Turn the VFO knob to your desired receive signal until the meter pointer is centered. (This meter has no effect on SSB and CW.)

③ POWER Switch

The power to the unit is turned ON by setting the power switch to the up position, and turned OFF at the down position.

④ Standby Switch

Set this switch to the down position for reception, and to the up position for transmission. By pressing the microphone PTT switch, the unit automatically shifts from reception to transmission.

⑤ VOX Switch

This switch is used for voice operated transmission on FM or SSB, or semi-break-in operation on CW (set to VOX position). It is also used in combination with the standby switch or microphone PTT switch (set to MAN position).

⑥ Meter Switch

By using this switch during transmission, the meter functions as an RF meter or ALC meter. During reception, the meter functions as an "S" meter regardless of the position of the switch.

(When the MODE switch is in FM, the meter will not function at ALC position.)

⑦ NB (noise blanker) Switch

Use this switch during SSB or CW operation to reduce pulse ignition type noise from automobiles, etc. This is very useful when receiving weak signals.

(This switch will not function in FM mode.)

⑧ LOW POWER Switch

Set this switch to LOW position and the FM transmit output is reduced to about 1 watt. Use the switch for FM mode only. (This switch has no effect on SSB and CW mode.)

⑨ ON AIR Indicator

This indicator will light during transmission.

⑩ LOW POWER Indicator

This indicator will light when FM transmit output is LOW (LOW POWER switch ON).

⑪ **F. LOCK Indicator**

This indicator will light when the LOCK switch is turned ON (VFO frequency is locked).

⑫ **RIT Indicator**

This indicator will light when the RIT switch is ON.

⑬ **Backup Indicator**

This indicator will light when the MEMORY B.U. switch (rear panel) is ON, indicating that the frequency stored in the microprocessor is retained even when the power switch is OFF.

⑭ **MIC Connector**

Connector for microphone input and PTT circuit.

⑮ **PHONES Jack**

This headphone jack allows use of a set of headphones of 8 ~ 16 ohms impedance. When plugged in, the built-in speaker is disconnected.

⑯ **MODE Switch**

By using this switch, any of the following four modes can be selected.

FM — (Frequency Modulations) (F3)

USB (Upper Side Band) — For operation in the 145 MHz and 430 MHz band, international practice calls for USB (A3J).

LSB (Lower Side Band) — A3J

CW — Morse-code telegraphic communications (A1)

⑰ **TONE Switch**

Tone oscillator switch which makes 1750 Hz FM wave when pressed in FM mode only.

⑱ **TIGHT lever**

This lever is used to increase the torque of the VFO dial knob so that the knob can not be rotated by external shock.

⑲ **CIR-END Switch**

With this switch set in the "END" position, turn the VFO knob and the frequency shifts from 0 to 999.9 and stops at that point. In the "CIR" position, the frequency will not stop at the 999.9 point but will return to 0 again.

⑳ **VFO Dial Knob**

The VFO covers from 0 to 1 MHz for each band.

㉑ **Digital Display**

The digital display indicates transmit and receive frequencies.

㉒ **Function Switch**

This 5-position switch selects one of the following transceive functions:

FIX — For fixed channel operation. Fixed channels (1 ~ 8 ch.) can be called by pressing the FIX-CH switch. The digital display indicates the selected channel numbers (1 ~ 8 ch.).

A — For VFO A operation.

B — For VFO B operation.

A-B — For VFO A operation during reception, and for VFO B operation during transmission.

B-A — For VFO B operation during reception, and for VFO A operation during transmission.

㉓ **VOX GAIN Control**

This control adjusts the sensitivity of the VOX circuit. Adjust it for optimum voice controlled operation.

㉔ **VOX DELAY Control**

This control adjusts the holding time of the VOX circuit. This is to be adjusted to the preference of individual operators.

㉕ **SSB MIC Control**

This control adjusts the gain of the microphone amplifier during SSB operation. Adjust it so that the ALC meter does not deflect beyond the ALC zone.

㉖ **CAR (carrier level) Control**

This control adjusts the carrier level during CW operation.

㉗ **RIT Control**

This control is used in conjunction with the RIT switch. With the RIT switch ON, the RIT knob allows the operator to vary the receive frequency without affecting the transmit frequency. The center position "0" is RIT-OFF.

㉘ **SQUELCH Control**

Turning this control clockwise during FM mode will activate the squelch circuit.

㉙ **AF GAIN Control**

This control adjusts the gain of the receiver audio amplifier. Clockwise rotation will increase the output level.

㉚ **RF GAIN Control**

For adjusting the RF amplifier gain of the receiver. The gain is minimum at the extreme counterclockwise position. Normally, this control is set in its extreme clockwise position.

㉛ **S/F Switch**

By using this switch, the frequency of the VFO is varied at a SLOW speed (in 20 Hz step) or FAST speed (in 200 Hz step). This switch is of the non-lock type; These SLOW and FAST frequency shift of VFO are altered by turns whenever it is pressed, and the operating conditions can be checked on the "FAST" indicator.

㉜ **RIT Switch**

This switch turns ON and OFF the RIT circuit.

㉝ **SCAN Switch**

This switch turns ON and OFF the scan circuit.

㉞ **SEARCH Switch**

This switch turns ON and OFF the SEARCH circuit.

㉟ **F. LOCK Switch**

This switch locks the VFO frequency being used. With the switch set to ON, the frequencies of VFO's (A and B) are stationary. This feature is useful for continued operation on the same frequency or for mobile operation.

The RIT switch is operable even when the F. LOCK switch is ON (BAND, SCAN and SEARCH switches are also operable). The F. LOCK indicator will light when the F. LOCK switch is ON.

⑫ MEMORY Switch

This switch is used to store the desired frequency in a fixed channel.

⑬ BAND Switch

For selecting the band to be operated. By pressing the UP switch, the frequency is stepped up band by band. When the DOWN switch is pressed, the frequency is stepped down band by band. By holding down either switch, the frequency is stepped up or down at about 0.5 seconds intervals.

⑭ FIX CH Switch

For selecting fixed channels (1 ~ 8 ch.). With the FUNCTION switch in the FIX position, press the FIX CH switch and the fixed channel is stepped up one by one. By holding this switch down, the fixed channel is stepped up at about 0.5 seconds intervals and when it reaches "8 ch", then it returns to "1 ch" for continuous counting.

⑮ FAST Indicator

This indicator will light at the FAST frequency shift operation of VFO.

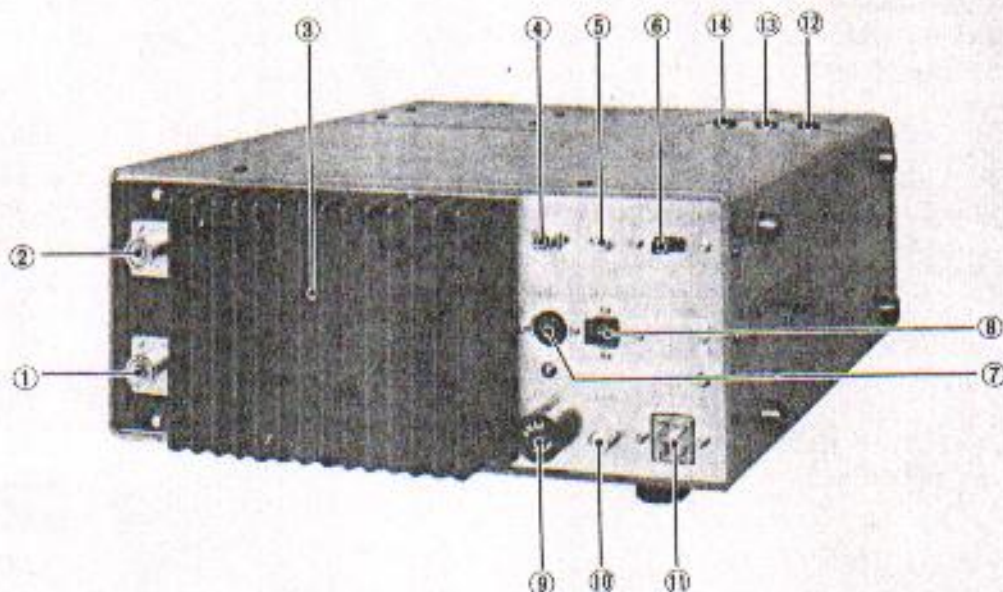

3-2. REAR PANEL

① 144 MHz ANT (antenna) Connector

For connection of the 144 MHz band antenna.

② 430 MHz ANT (antenna) Connector

For connection of the 430 MHz band antenna.

③ Heat Sink

Dissipates heat from the final stage transistors and power supply transistors.

④ KEY Jack

This jack is used for operating the unit in CW mode. Connect an external telegraph key.

⑤ EXT SP (external speaker) Jack

For connection of an external speaker of 4 ~ 8 ohms impedance.

⑥ MEMORY B.U Switch

Set this switch to ON and the fixed channel frequency stored in the microprocessor is retained even when the power switch is turned OFF.

With the MEMORY B.U switch in ON position, backup

power is supplied to the microprocessor as long as the AC (or DC) power cord is connected properly to the AC source (or battery). The backup indicator will light when the switch is ON.

⑦ AUX socket

This connector is used for controlling a linear amplifier, etc., or for external standby. For connection, use the supplied 7 P plug (DIN type).

⑧ B.U BATT Connector

This connector is used for the optional battery back-up (BU-1).

⑨ Fuse

A 2A fuse. When it blows, check the cause and replace with the spare supplied.

⑩ GND (earth) Terminal

For connection of an earth lead.

⑪ Power Connector (AC and DC)

For connection of the supplied AC power cord or the specified DC power cord (DC 13.8V).

⑫ **FM MIC Control**

This control adjusts the sensitivity of the microphone during FM transmission.

⑬ **SIDE TONE Control**

This control adjusts the monitoring level of side tone during CW operation.

⑭ **ANTI VOX Control**

This control adjusts the gain of the ANTI VOX circuit during VOX operation.

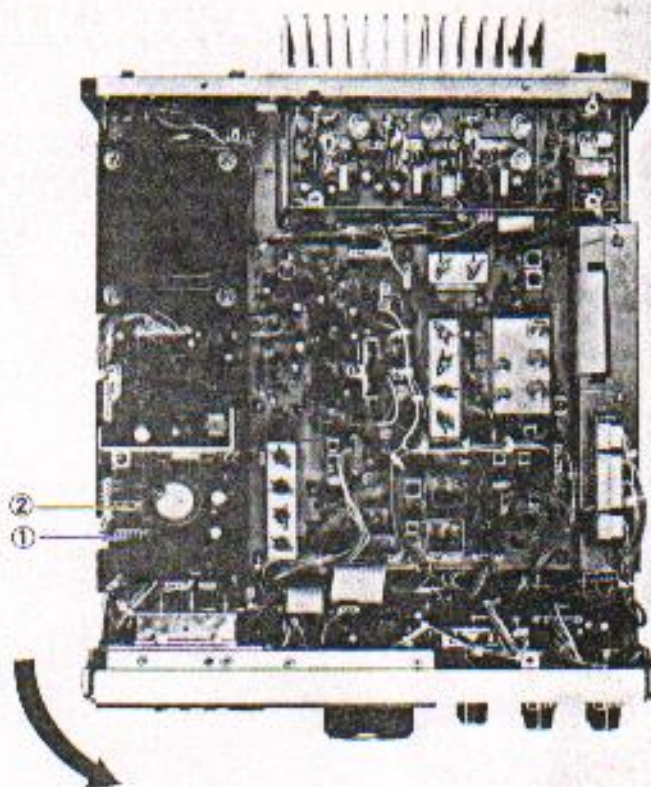

3-3. SELECT SWITCHES INSIDE CASE

(Remove the upper case and change the position of the connector if necessary.)

① **DISP (NORM ◀, ▶)**

In the NORM ◀ position, the unnecessary digit at the end of frequency read out disappear from the digital display; in FM mode, the 100 Hz digit disappears.

In the NORM ▶ position, all 7 digits appear on the digital display. This switch is pre-set in the NORM ◀ position prior to shipment.

When the FUNCTION switch is in FIX position, the frequency is always displayed in 7 digits.

② **BZ (ON ◀, ▶)**

When the BAND switch and FIX CH switch are pressed, or when the VFO is switched from 999.9 to 0 in endless mode, a tone pulse will be heard from the speaker. This noise can be eliminated by using the BZ switch. This switch is pre-set in the ON position prior to shipment.

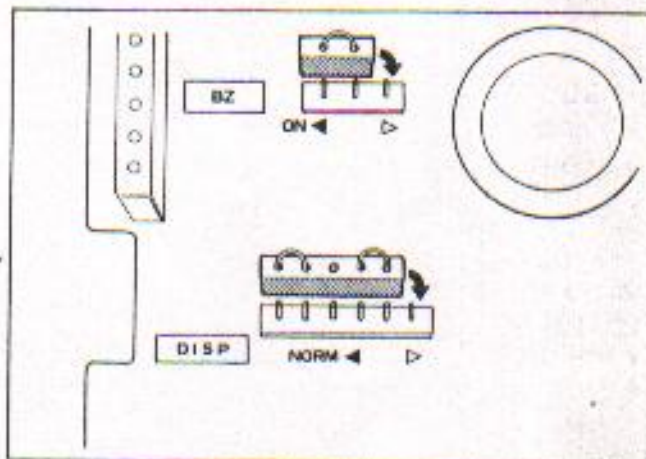

Fig. 3 Select Switches inside Case

SECTION 4. PRELIMINARY

4-1. ANTENNA

The performance of the transceiver depends upon the type of antenna to be used. To ensure the maximum performance of the TS-770, select a suitable antenna and adjust it for the best condition.

Common Antenna for 144/430 MHz Operation

The TS-770 is designed so that two different transmit outputs (144 and 430 MHz) are supplied to individual antennas. Use of individual antennas is recommended as it simplifies the antenna matching and minimizes the loss caused by antenna. However, if it is desired to use a common antenna, available from market, because of installation conditions, etc., it should be properly adjusted and connected by carefully following the instruction manual furnished with the antenna. An example of connection of a common antenna is illustrated in Fig. 4.

Notes:

1. A common antenna should be connected through a dividing filter (some types of common antenna have built-in dividing filter).
2. An antenna selector (up to 430 MHz) may be used in lieu of a dividing filter.
3. Never attempt to connect a common antenna without using a dividing filter.

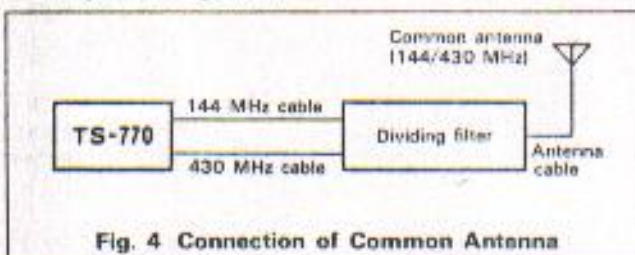

Fig. 4 Connection of Common Antenna

Type of Antenna

Choose a proper antenna according to whether it is used for fixed station or mobile station operation. For fixed station operation, a Yagi antenna (directional type) or a ground plane antenna (omnidirectional type) is recommended.

Antennas for fixed station operation should be installed observing the following three conditions:

• Selection of Antenna

Choose an antenna suitable for the purpose of use, budget and installation location.

In general, a beam antenna such as Yagi antenna is suitable for operation with DX stations or a specific station, and a ground plane omnidirectional antenna for operation with local stations. In the case of Yagi antennas, use of a stacked type antenna as shown in Fig. 5 will provide excellent directivity and RF gain.

• Installation Location

For satisfactory DX operation, the antenna should be installed as high as possible. An example of a good location for the installation of antenna is on a hill such as illustrated in Fig. 6, "A" station.

Installing an antenna in such a high location allows reception of many stations; however, this often creates a possibility of radio interference. Therefore, it is recommended that a stacked type directional Yagi antenna be used for satisfactory DX operation.

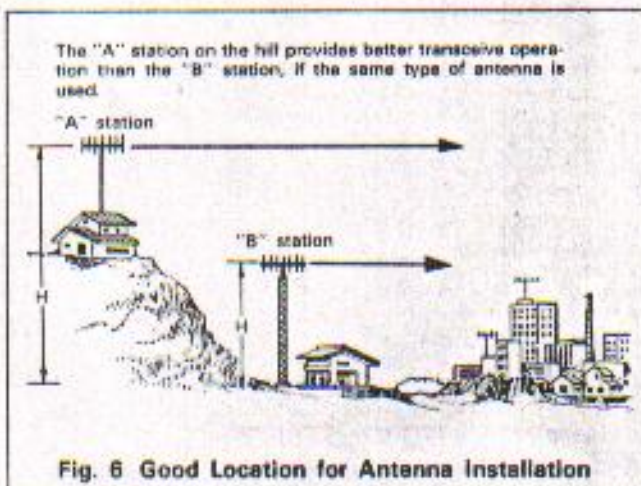

Fig. 6 Good Location for Antenna Installation

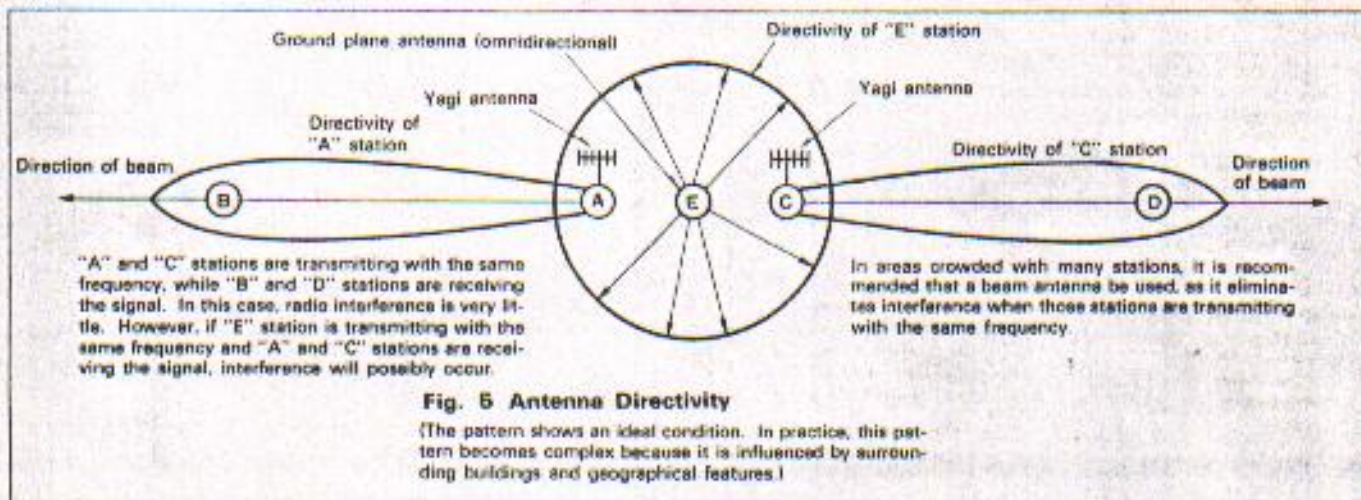

Fig. 5 Antenna Directivity

(The pattern shows an ideal condition. In practice, this pattern becomes complex because it is influenced by surrounding buildings and geographical features.)

● Adjustment (SWR)

Your antenna must be connected to a 50 ohms coaxial cable, since the antenna impedance of the TS-770 is 50 ohms. Also, the antenna must be adjusted to 50 ohms impedance. This adjustment is called impedance matching.

Proper impedance matching is accomplished by checking SWR (VSWR: Voltage Standing Wave Ratio) using a SWR meter. Ideal SWR is 1:1.

The SWR meter should be connected between the antenna feeder and the antenna terminal at the rear of the transceiver, whichever is more convenient. Note that the reading of SWR meter varies somewhat depending on the location of connection because of the loss in the antenna cable. This is particularly noticeable when the antenna cable is more than 10m long.

An antenna system which shows a standing wave ratio of less than 1.5 will insure satisfactory transceive operation.

should be used, as the loss of coaxial cable cannot be neglected when operating in high frequency bands, particularly in 144 MHz or higher bands.

When the coaxial cable needs to be extended more than 10m, use one of larger size such as 8D-2V, 10D-2V, RG8/U or UR67.

4-2. COAXIAL CABLE

For satisfactory transceive operation, coaxial cable must be used. When the transceiver is used for fixed station service, the coaxial cable becomes relatively long, so low loss (large sized) coaxial cable of the shortest possible length

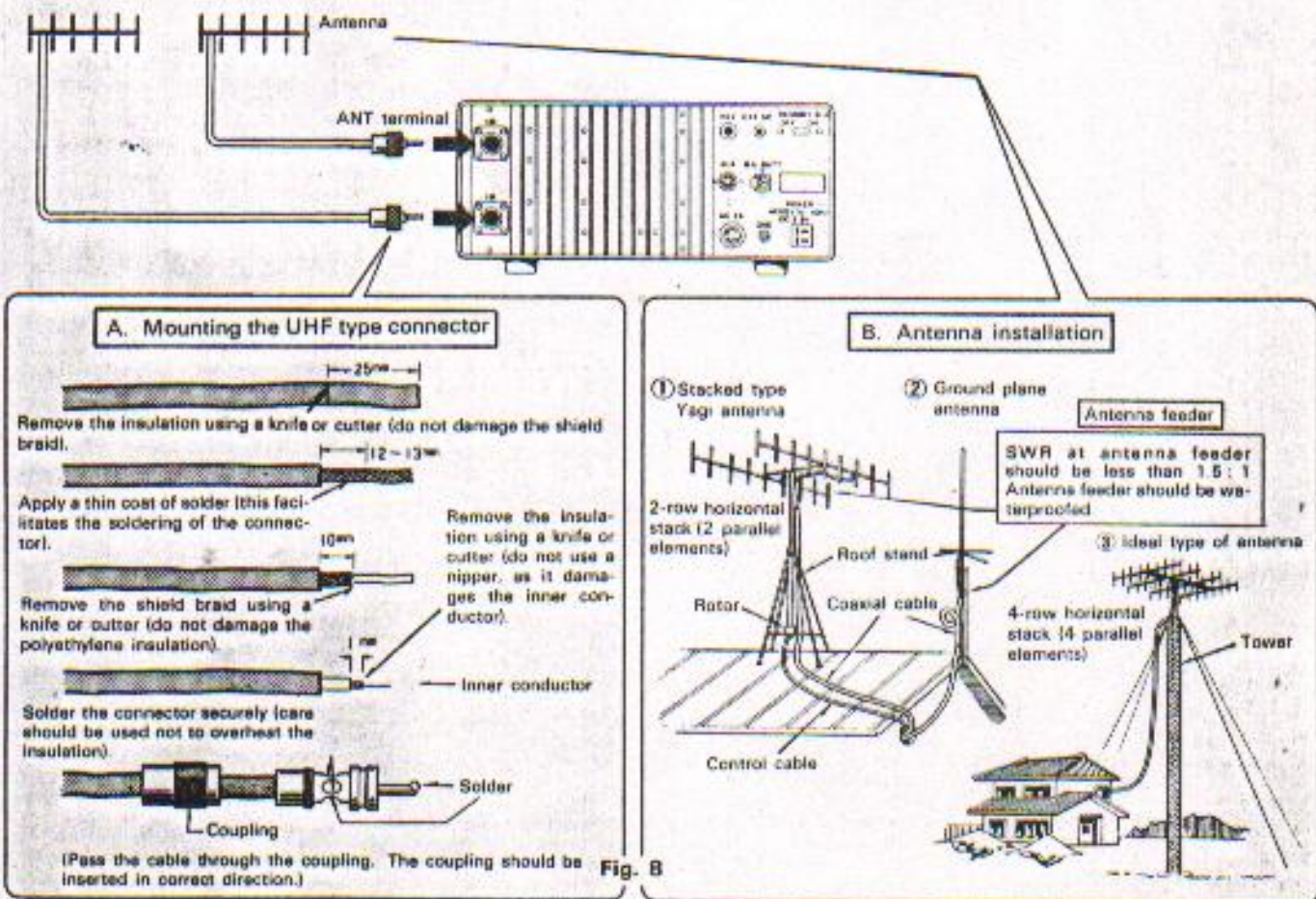
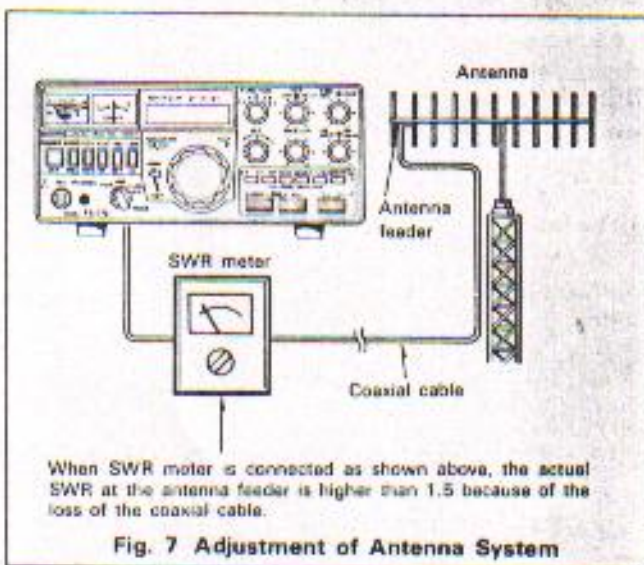

SECTION 5. OPERATING INSTRUCTIONS

5-1. OPERATING MODES

The TS-770 can be operated in the following modes by using the MODE switch.

CW — Transmission and reception of Morse signals (A1)

FM — Transmission and reception of FM signals (F3)

USB — Upper side band transmission and reception (A3j).

USB is normally used on 144 and 430 MHz bands.

LSB — Lower side band transmission and reception (A3j).

5-2. FM MODE

Reception

Set the knobs and switches as shown in Fig. 9, then proceed as follows:

1. Turn the POWER switch ON. The meter and digital display are illuminated to indicate the power is on. The digital display indicates 144,000 MHz and the VFO indicates "A".

Next, press the BAND switch (DOWN or UP) to set the operating frequency. By pressing the switch, the fre-

quency is stepped up (or down) band by band at 0.5 seconds intervals.

2. Turn the AF GAIN control clockwise and noise or signal will be heard from the speaker. Adjust the control for suitable volume. To eliminate the noise under no-signal conditions, use the SQUELCH control.
3. Turn the VFO knob slowly for the clearest signal observing the S meter.
4. The meter (B) functions as a center meter. Adjust the VFO knob so that the meter is centered. In this way, the transmit frequency will coincide with the receive frequency. Since the IF band is wide in FM mode, a slight deviation of frequency does not affect the reception. In transmitting operation, however, the other party may be using a fixed channel, so it is advisable to set the meter in the center position (zero-in) by adjusting the VFO dial knob.

* Zero-in means that your transmit frequency coincides precisely with the receive frequency.

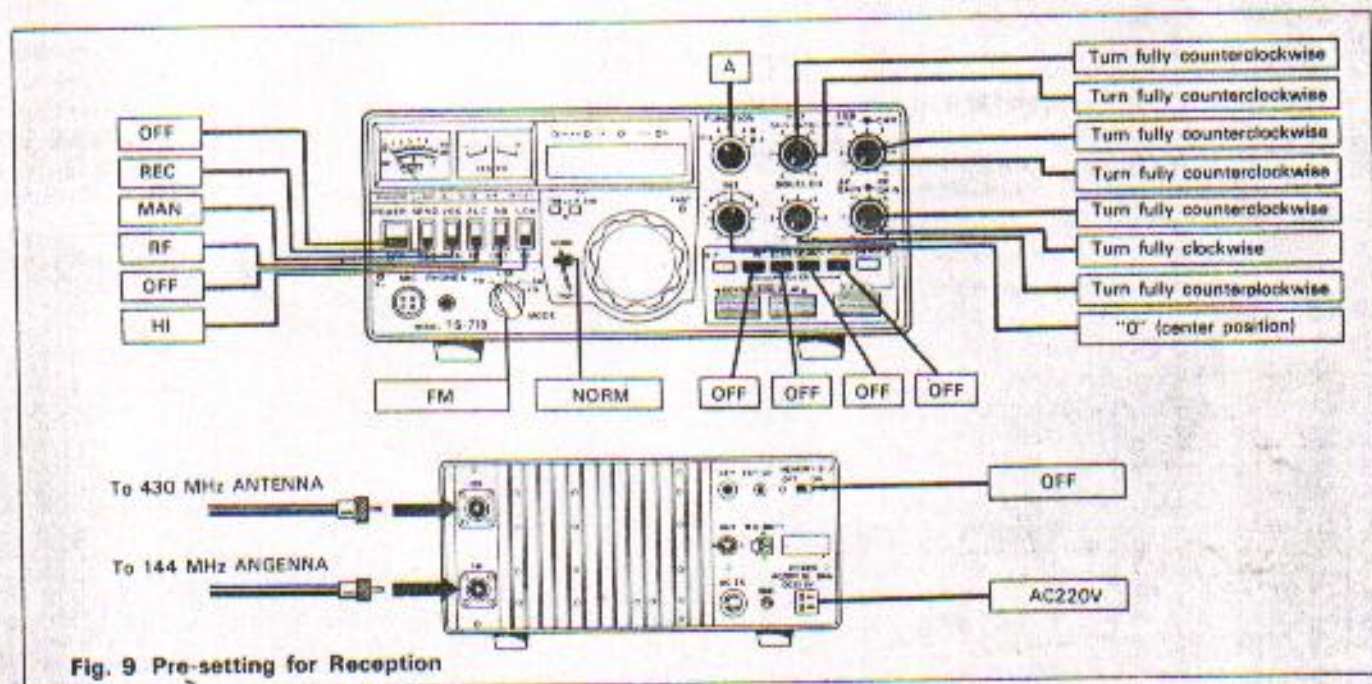

Use of RIT Switch

The RIT (Receiver Incremental Tuning) switch is used to shift the receive frequency by about ± 2 kHz without affecting the transmit frequency (the indication of digital display remains unchanged).

When the receive frequency is offset, turn on the RIT switch (the RIT indicator will light) and turn the RIT control so that the transceiver is tuned in the frequency.

Note that the receive frequency is offset from the transmit frequency when the RIT switch is turned on, so the switch must be set to OFF after QSO. The RIT function is also operational on VFO, FIX-CH and CALL-CH.

Use of RF GAIN Control

This is used to adjust the receiver RF stage gain. Normally, leave it fully clockwise. For a very strong incoming signal, turn it counterclockwise. If there is a strong signal in the vicinity of your operating frequency, lower the RF gain to reduce intermodulation interference.

Use of SQUELCH Control

This control is used to eliminate noise when signal is absent. Turn the control slowly until noise disappears. When the control is properly adjusted, only the receive signal is heard from the speaker. This control is also used according to the strength of input signal during mobile operation.

Transmission

Notes:

1. Before transmitting, perform all the necessary procedures for optimum reception. Make sure that the frequency you have selected does not interfere with other stations.
2. Check to make sure that the antenna connected is of the proper type. Use of an improper antenna will result not only in insufficient power but also in TVI and BCI. Do not attempt to operate the transceiver without connecting antenna as it will cause damage to the transceiver.

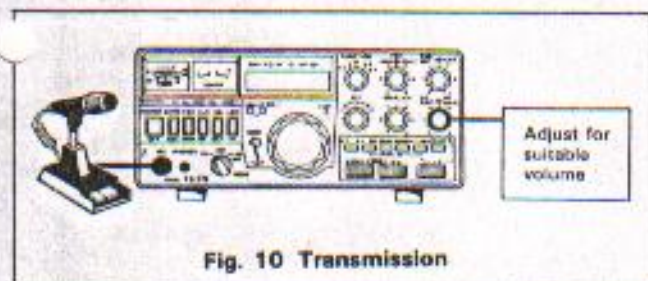

Fig. 10 Transmission

Set the controls referring to Fig. 9. For transmission, use the following procedure:

1. Set the MODE switch to FM and the STANDBY switch to SEND (when the PTT switch is pressed, signal is transmitted at the REC position of the standby switch). Check to see that the RF meter is working and the ON AIR indicator is lit. Set the STANDBY switch to REC.
2. Adjust the microphone gain by turning the FM MIC control. Normally, optimum gain is obtained in the center position of the knob. If required, turn the control counterclockwise to reduce the gain.

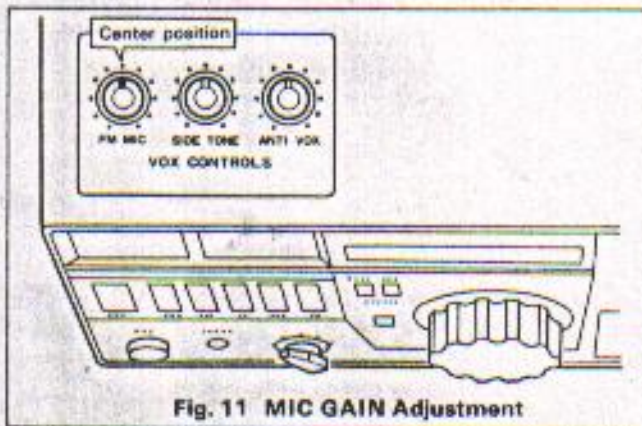

Fig. 11 MIC GAIN Adjustment

Use of LOW POWER Switch

This switch is used to reduce transmit power during operation with a local station, thus preventing interference to other stations. It is also effective to reduce the power consumption.

Set the switch to the up position and the transmit power is reduced to about 1 watt when the LOW POWER indicator will light.

The transmit power is indicated on the RF meter. Since the indication on the RF meter depends on the installation condition of antenna, it will not indicate the exact output power. If the meter indicates "8" at the rated power, then the reading of the meter will be "1" or "2" when the LOW POWER switch is turned on.

Note:

The LOW POWER switch is used in FM mode only.

5-3. SSB Mode

Reception

On VHF bands, USB is traditionally more often used than LSB. As far as the operating technique is concerned, there is no difference between two. Generally, the "zero-in" technique in SSB mode required a little experience.

For SSB operation, set the knobs and switches as described in section on "FM Mode", except that the MODE switch should be in USB position.

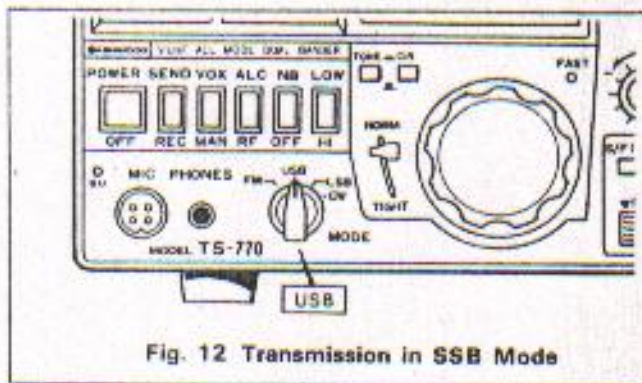

Fig. 12 Transmission in SSB Mode

After the settings have been completed, proceed as follows:

1. Turn the POWER switch ON and adjust the AF GAIN knob for suitable loudness.
2. Turn the VFO tuning knob slowly to receive SSB signal. First set the VFO knob a few kHz lower than the receive frequency (turn the knob counterclockwise) and you will hear a high pitched tone such as is heard from a magnetic recording tape set in the fast-forward mode. Turn the knob clockwise for higher frequency and the sound will become clearer. Set the knob in such a position where the sound is heard most clearly (this is the zero-in point).

Note:

The zero-in point can be easily located because the sound loses its clarity suddenly when the frequency passes away from the zero-in point. If a clear sound cannot be heard by following the above procedure, it may be an indication that the signal is LSB. Set the MODE switch to LSB position. In this case, the setting of the VFO knob should be made in reverse order.

Transmission

1. Set the MODE switch to USB and the meter switch to ALC. Other controls remain the same as outlined in section on "FM Mode".
2. Adjust the microphone gain. This adjustment should be made with the standby switch set to SEND or the microphone PTT switch depressed. Next, speak into the microphone and adjust the SSB MIC gain control on the front panel, making sure that the ALC meter does not deflect beyond the ALC zone. After completion of the above adjustment, set the meter switch to RF.

Discrimination between SSB and FM**1. Use of S meter**

If the S meter is steady (meter pointer almost stops), the incoming signal is FM; otherwise, it is SSB.

2. Use of MODE switch

If a clear signal is heard at the FM position of the MODE switch, the signal is FM. The sound in SSB mode is not heard at this position.

Use of RIT Switch

For detailed information, refer to section on "FM Mode". In SSB mode, if the receive frequency has drifted, set the RIT switch to ON and adjust the RIT knob, as in the case of FM mode.

When the RIT switch is ON, the receive frequency is offset from the transmit frequency, so it is necessary to turn the switch off when tuning to another frequency.

Use of NB (noise blanker) Switch

The NB switch is used to suppress pulse noise such as ignition noise generated by car engine.

Use of RF GAIN Control

For detailed information, refer to section on "FM Mode". Normally, this control should be left in full clockwise position. When a very strong incoming signal is present, turn it counterclockwise. The noise level below the receive signal level is attenuated for clear reception.

If the RF GAIN is reduced excessively in SSB or CW mode, the S meter deflection will increase irrespective of incoming signal strength. This is due to the circuit characteristics and is not an indication of trouble.

The secret of reading accurate signal strength is to turn the RF GAIN control counterclockwise so that it is a little lower than the signal level read on the S meter at the full clockwise position, as shown in Fig. 13.

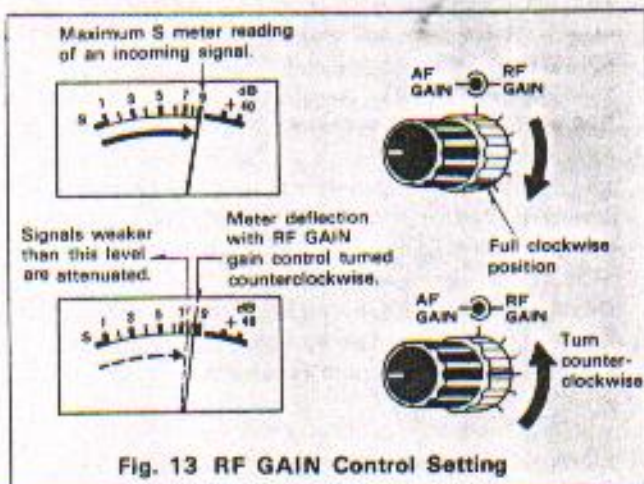

Fig. 13 RF GAIN Control Setting

5-4. CW Mode**Reception**

Set the controls and switches as outlined in section on "FM Mode", except that the MODE switch should be set to CW. For reception, proceed as follows:

1. Turn the POWER switch ON and adjust the AF GAIN control for suitable volume.
2. Turn the VFO knob slowly for the desired receive signal so that a 800 Hz beat is heard. In this way, the frequency of your station will coincide (zero-in) with the frequency of your party's station.

Similarly, if your party calls back with a 800 Hz beat in response to your call, it means that the party's frequency has coincided with your frequency.

Note:

The 800 Hz beat can be checked by using a frequency counter.

Transmission

Adjustments of the transmitter for CW operation are basically the same as for FM operation. The transceiver will be ready for use when adjusted in FM mode provided that the frequencies are the same.

For transmission, set the controls and switches as outlined in section on "FM Mode", except that the MODE switch should be set to CW and the meter switch to ALC. Connect your key to the KEY jack on the rear panel.

1. Check to ensure that the MODE switch is set to CW. Set the standby switch to SEND and the ON AIR indicator will light. Under this condition, press the key down and the ALC meter should deflect. Set the standby switch back to REC position.

Note:

If the key is not connected, the ALC meter will deflect when the standby switch is set to SEND.

2. Adjust the CAR LEVEL control

With the standby switch in the SEND position, adjust the control so that the ALC meter deflects within the ALC zone when the key is pressed down.

Then, release the key. Set the standby switch back to REC position and the meter switch to RF position.

3. Adjust the side tone.

The TS-770 has a built-in side tone circuit for monitoring your station's CW signal during transmission. To adjust the side tone volume, open the top cover and turn the SIDE TONE control for desired level.

This adjustment should be made in receive mode with the key pressed down (standby switch in REC position), since, in so doing, the side tone circuit is activated.

Use of RIT Switch

For detailed information, refer to section on "FM Mode". Use the RIT switch when your party's frequency has deviated from 800 Hz or you wish to transmit with a different beat frequency.

Use of NB Switch

Refer to section on "SSB Mode".

Use of RF GAIN Knob

Refer to section on "SSB Mode".

Semi-Break-In Operation

The TS-770 is capable of semi-break-in operation, in addition to the usual CW operation with the standby switch.

The semi-break-in uses the side tone to activate the VOX circuit which switches to transmit when the key is pressed down and to receive when it is released. For semi-break-in operation, set the MODE switch to CW and the VOX switch to ON. Other operating procedures are the same as for the usual VOX operation (Refer to 5-5).

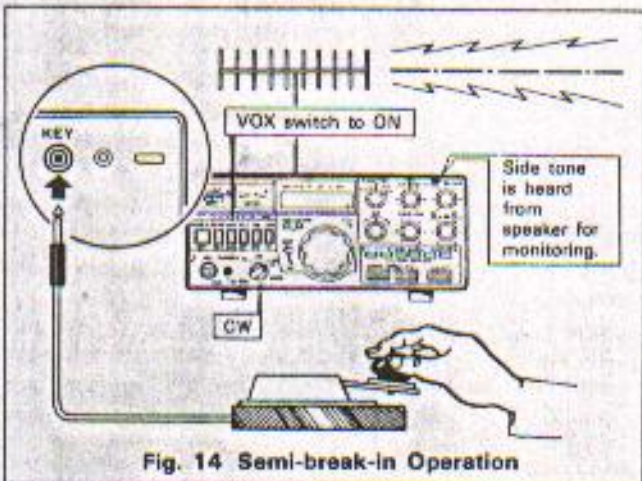

Fig. 14 Semi-break-in Operation

5-5. VOX OPERATION

The VOX is an automatic switching system that switches the transceiver to transmit and receive while speaking into the microphone. This is mainly used in SSB mode.

With the VOX switch set to ON, the transceiver is automatically switched to transmit mode when you speak into the microphone and to receive mode when you stop talking. For VOX operation, the standby switch should be set to REC.

Control Settings**1. Adjustment of VOX GAIN Control**

with the standby switch set to REC, place the VOX switch in the VOX (ON) position.

First turn the VOX GAIN control clockwise and adjust it so that the transceiver is switched to transmit mode when you speak into the microphone with normal voice. Turn the control further clockwise and the gain is increased allowing the transceiver to be switched to transmit mode with a lower level of voice. However, excessive VOX gain results in misoperation by ambient noise.

The condition of VOX operation can be checked through the speaker. When any sound is heard from the speaker, it means that the transceiver is in receive mode; otherwise, it is in transmit mode. In transmit mode, the ON AIR indicator comes on and, in receive mode, the light of indicator goes off.

2. Adjustment of ANTI VOX GAIN Control

This control is located on top of the case (see page 9) and is used to prevent the VOX circuit from being misoperated by the sound of speaker.

Adjust the VOX GAIN control as directed in item (1) above. Then, adjust the AF GAIN control for suitable volume while receiving signals from a station.

Hold the microphone 20 ~ 30 cm from the speaker and adjust the ANTI VOX GAIN control until speaker sound will not activate the VOX circuit. Excessive turning of the control in clockwise direction will cause the ANTI VOX circuit to operate, resulting in failure of the transceiver to be switched to transmit mode.

3. Adjustment of VOX DELAY Control

This control is used to hold the transmitter on after VOX operation. If the hold time is too short, the TS-770 returns to receive whenever you pause speaking. If too long, the TS-770 will not return to receive after speaking. Adjust the control so that the transceiver holds proper transmitting time when you speak at normal speed.

This control is also effective for CW semi-break-in operation.

During CW operation, do not turn the control excessively in clockwise direction, as it takes a long time until the transceiver returns to receive when the key is released; making it impossible to perform smooth semi-break-in

operation.

Note:

If the VOX switch is left ON, the TS-770 will momentarily transmit when the POWER switch is turned on. After VOX operation, set the VOX switch to OFF.

5-6. READING THE FREQUENCIES

The TS-770 digital display indicates carrier positions in all operating modes. Because of the use of a special circuit, the carrier position remains the same when the MODE switch is manipulated, thus the transmit and receive frequency can be directly read on the digital display, except for CW reception where the frequency on the display is higher by the beat frequency (800 Hz; see section on "CW Mode") than the transmit frequency.

Note:

The digital display does not indicate the frequency varied by the RIT knob.

5-7. BAND SWITCH (UP-DOWN)

The BAND switch consists of two pushbutton switches, UP and DOWN. By pressing the UP switch, the frequency is shifted up by 1 band and, by pressing the DOWN switch the frequency is shifted down by 1 band. By holding either switch down, the frequency is shifted continuously at 0.5 seconds intervals. As shown in the illustration below, the BAND switch functions separately for the VFO A and B (see section 5 ~ 9 on "Operation of 2 VFO's"). The BAND switch uses feather-touch pushbutton switches. A tone pulse is heard whenever the switch is pressed.

5-8. DIGITAL VFO

The TS-770 VFO is designed so that the pulses generated by rotating the VFO knob are counted by the microprocessor to vary the frequency through PLL circuit. The frequency is varied step by step. The step interval is 20 Hz (SLOW) for CW and SSB operation or 200 Hz (FAST) for fast-forward and FM operation. Either step can be selected by the S/F switch (see section 5-10).

The adjustable range of the digital VFO is shown in Table 1.

	S/F Switch "SLOW"	S/F Switch "FAST"
144 MHz BAND	144,000.00 ~ 144,999.98	144,000.00 ~ 144,999.80
146 MHz BAND	145,000.00 ~ 145,999.98	145,000.00 ~ 145,999.80
430 MHz BAND	430,000.00 ~ 430,999.98	430,000.00 ~ 430,999.80
439 MHz BAND	439,000.00 ~ 439,999.98	439,000.00 ~ 439,999.80

Table 1

In each band, the VFO dial stops at 0 or 999.9 (999.8 kHz). Endless operation (0 follows 999.9 or 999.8) of the VFO dial is also possible by changing the position of the CIR-ENDSwi-ch. During endless operation, a tone pulse is heard when the VFO dial reaches 0 or 999.9 (999.8), allowing you to confirm the band edge (see page 10, 3-3 ②).

The VFO knob is of variable torque type. When the lever at the left of the knob is set to NORM, the knob can be rotated quickly because of the flywheel effect. When the lever is set to TIGHT, the knob is given a heavy torque and hence the knob will not rotate accidentally by external shock. This feature is useful for fine tuning or mobile operation.

5-9. OPERATION OF 2 VFOs

The TS-770 has two VFO's, A and B, each being controlled by a microprocessor.

By using the FUNCTION switch, the desired VFO can be selected. The use of two VFO's also permits operation with their own frequencies (cross channel operation) such as A-B or B-A operation. The table below shows the positions of the FUNCTION switch and VFO's selected.

FUNCTION SWITCH	RECEPTION		TRANSMISSION	
	VFO used	Digital Display	VFO used	Digital Display
A	A	144,145.2	A	144,145.2
B	B	431,241.0	B	431,246.0
A-B	A	144,145.2	B	431,246.0
B-A	B	431,246.0	A	144,145.2

Table 2

(For the FIX position of the FUNCTION switch, refer to section 5.0 "FIX CH".)

As shown in the table above, the two VFO's can be operated either in the same band or different bands. The VFO's also have memory functions.

Examples:

1. With your contact's schedule frequency stored in VFO B, you can operate VFO A until your contact starts transmitting.
2. During FM operation, you can locate a sub-channel by the VFO not in use.

Note:

Each VFO is capable of setting frequencies in the 144 and 430 MHz bands. As the frequency bands are selected by the FUNCTION switch, the antennas for 144 and 430 MHz bands must be connected securely.

5-10. S/F (SLOW/FAST)

1. This switch is used to change the VFO steps in each mode to S (SLOW): 20 Hz or F (FAST): 200 Hz. The steps SLOW and FAST are switched alternately each time the switch is pressed down. The operating condition is indicated by the "FAST" indicator. This indicator lights when the switch is in the FAST step.

In SSB or CW mode, set the switch to the S (SLOW) position. If it is desired to advance the frequency quickly, set the switch to the F (FAST) position.

In FM mode, the switch can be set to the FAST (200 Hz step) position for proper operation since the FM frequency band is broad.

The S/F switch is automatically set to the SLOW position when the FUNCTION switch is manipulated or the transceiver is switched from receive to transmit during cross channel operation.

The relationship between the positions of the S/F switch and the operating frequencies (digital display) is as follows:

- When the switch is set from SLOW to FAST, the 100 Hz digit is cleared and "0" appears instead. When the switch is set to SLOW again, the digital display indicates the SLOW frequency.
- When the FUNCTION switch is set from VFO: A to VFO: B, the light of the FAST indicator goes off and the VFO: B operates in SLOW mode. When the FUNCTION switch is set to VFO: A again, the VFO: A also operates in SLOW mode.
- When the FUNCTION switch is set to VFO: A-B or B-A (cross channel operation), the VFO A or B operates in SLOW mode when it is switched from receive to transmit. At this time the light of the S/F indicator goes off.

Note that the 100 Hz digit may change when the power switch is turned on and off while the S/F indicator is ON. This is normal and not a sign of trouble.

5-11. FIXED CHANNEL OPERATION (FIX-CH)

The TS-770 has 8 fixed channels. Any channels can be preset (memory) as desired.

With the FUNCTION switch set to FIX, only the number of fixed channel appears on the digital display, indicating that no frequency is stored in the fixed channel. Under this condition, press the FIX CH switch and the number of fixed channel varies from 1 to 8 continuously.

Examples:

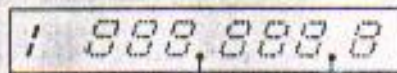

Number of fixed channel (1 - 8 ch)

Frequency not displayed.

Place indicator displayed

The channel number advances by 1 channel whenever the FIX CH switch is pressed. By holding the switch down, it advances continuously at about 0.5 seconds intervals, while a tone pulse is heard at each channel.

Storing the FIX CH frequency

The frequency (digital display) of the VFO A or B in 144 or 430 MHz band can be stored even when the MODE switch is in FM-CH position.

- Set the VFO A or B to the frequency to be stored.
- With the FUNCTION switch in FIX position, press the FIX CH switch so that the desired fixed channel appears on the digital display.
- Set the FUNCTION switch to A or B position.
- Press the MEMORY switch. The frequency of the VFO A or B will be stored in the fixed channel.
- The channel number and the frequency can be checked on the digital display by setting the FUNCTION switch to FIX position.

If you desire to store another frequency, use the procedure in (2.) above.

Any frequency can be stored in any of the 8 channels.

How to clear stored FIX CH frequency

The frequency stored in a fixed channel can be cleared when another frequency is stored in the same channel. Also, it is cleared when the power cable is disconnected provided that the back-up power is not used.

Note:

When a stored frequency is cleared, do not press the MEMORY switch as it changes the frequency. Be sure to observe the procedure in item (2.) above. Note that the stored frequency is cleared when the POWER switch is turned OFF. Make certain that the MEMORY B.U switch on the rear panel is in ON position (see section 5-15).

FIX CH operation

For operation on a fixed channel in which a frequency is stored, set the FUNCTION switch to FIX and press the FIX CH switch to the desired fixed channel. Then, set the MODE switch to the desired mode. The fixed channel operation is achieved the same as VFO operation. The RIT switch also functions during FIX CH operation.

5-12. USE OF SCAN SWITCH

The TS-770 SCAN switch can be used during VFO or fixed channel operation. The SCAN circuit is activated when the switch is set to ON.

CW, SSB or FM mode

The frequency is scanned when the SCAN switch is turned ON. When the frequency reaches the upper end of the band, it returns to 0.

The frequency is scanned over 1 MHz in 20 kHz steps when the "FAST" indicator is ON, and in 5 kHz steps when the indicator is OFF.

SCAN in FIX channel

It is also possible to scan the fixed channels (8 ch). Set the FUNCTION switch to FIX and the SCAN switch to ON. The fixed channels are scanned in order from 1 ch to 8 ch and then to 1 ch (endless scan). When the MODE switch is set to FM, the SCAN is started by the squelch knob and stops at an input signal, as in the case of VFO SCAN operation. In other modes, the SCAN is not effected by the squelch knob.

5-13. USE OF SEARCH SWITCH

This switch is mainly used in SSB and CW modes. By setting the SEARCH switch to ON, the VFO frequency is shifted, in 200 Hz steps, to a frequency 100 kHz higher than the original frequency. For example, when the switch is set to ON at 431,000.0 MHz, the frequency is searched about 100 kHz upwards in about 1 second starting from 430,100.0 MHz and returns to the starting frequency in about 1 second. This operation is repeated.

At the same time, the frequency on the digital display also changes at the same speed. Since the SEARCH operation stops momentarily at each cycle, the condition of SEARCH and the starting frequency can be checked.

In CW or SSB mode, a beat is heard when an input signal comes in the 100 kHz band. In FM mode, a voice signal is heard momentarily.

When the signal is heard in the wanted frequency zone, turn OFF the SEARCH switch and locate your wanted signal by turning the VFO knob.

Unlike SCAN operation, the SEARCH operation enables you to receive your signal quickly because a narrow frequency range (100 kHz) is searched in 200 Hz steps. This feature is useful for standby reception in SSB or CW mode, particularly in 430 MHz band where there are fewer SSB stations.

Note that transmission is not possible in the ON position of the SEARCH switch. If the SCAN switch and the SEARCH switch are pressed at the same time, the SEARCH switch takes precedence over the SCAN switch.

Note:

If the FUNCTION switch is switched to VFO B (or A) during the SCAN or SEARCH operation using VFO A (or B), the digital display indicates "B" (or "A"). The SCAN or SEARCH operation will still continue using VFO A (or B) until the SCAN or SEARCH switch is turned OFF. The reception frequency is then determined with VFO B (or A).

5-14. BACK-UP OF FIXED CHANNEL FREQUENCY (MEMORY)

Fixed channel frequencies stored in RAM of the built-in microprocessor (see section 5-11 on FIX CH Operation) are cleared when the POWER switch is turned OFF.

To avoid this, a back-up circuit is provided so that the stored data (frequency) is not cleared when the POWER

switch is OFF during AC or DC operation. This circuit supplied power to the RAM (Random Access Memory) of the microprocessor when the POWER switch is OFF, so the frequency remains stored as long as the MEMORY B.U switch on the rear panel is set to ON. This is also effective for VFO frequency being used.

When the MEMORY B.U switch is set to ON, the B.U indicator will light.

During AC operation, it is advisable to set the MEMORY B.U switch to ON. The back-up power consumption is about 1 watt. If the back-up power is not used, the VFO frequency returns to 144,000.0 MHz when the POWER switch is turned on and off.

Note:

If the AC power cord is disconnected from the outlet, the back-up circuit will not function, causing the stored data (frequency) to be cleared.

A separate power supply unit is available as option (see section 6 on page 22). By using this unit, the data remains stored even after the AC power cord is disconnected or when a power failure continues for a few hours.

The back-up function is also effective when the transceiver is operating on car battery or other DC power (12V). To do this, the following points should be observed:

1. Connect the DC power cord directly to the car battery, not through the ignition switch. Do not connect any switch to the DC power cord. Note that if the cord is connected to the car's cigarette lighter socket, the stored data will be cleared if the cord is accidentally disconnected from the socket.
2. During mobile operation (DC12V), the transceiver draws about 40 mA of back-up current. When the car is not to be used for any length of period, the back-up power should be turned OFF to prevent the battery from being discharged.
3. The back-up circuit will not operate when the battery voltage drops below 7.5V.

When the car is started, the battery voltage drops momentarily. If it drops below 7.5V, the stored data may be cleared or the indication of the digital display may be changed. In this case, turn the power switch and the MEMORY B.U switch to OFF and then to ON. The FIX CH frequency will be cleared and the VFO frequency turns to 144,000.00 MHz. The transceiver will now operate normally. To prevent such a misoperation, a separate back-up power unit (BU-1) is available as an optional accessory.

The BU-1 is used only when AC power is interrupted for a short period of time or the car is started. It cannot be used for continuous back-up operation (more than 8-10 hours).

5-15. OPERATION ON EXTERNAL DC POWER (MOBILE OPERATION)

The TS-770 also operates on external DC power (DC13.8V) for mobile operation.

Installation

The method of mobile operation is basically the same as that of fixed station operation.

Select a suitable location for installation of the transceiver. The installation location may vary depending on the size and structure of car. The transceiver may be placed on the passenger's seat; in this case, it should be secured with the seat belt so that it will not drop off the seat if the car stops suddenly.

Mobile Antenna

Various types of mobile antennas are available for use on 144 and 430 MHz bands. You can use a 1/4 wavelength whip antenna, ground plane antenna or 5/8 wavelength antenna.

Note:

Most roof mount antennas are designed so that the antenna base is earthed to the car body. Mount the antenna securely referring to the instruction manual supplied with the antenna.

DC Cable

When the transceiver is to be operated from DC power, a DC power cable with an 8A fuse should be used.

In DC operation, please prepare a DC cable as Fig. 15.

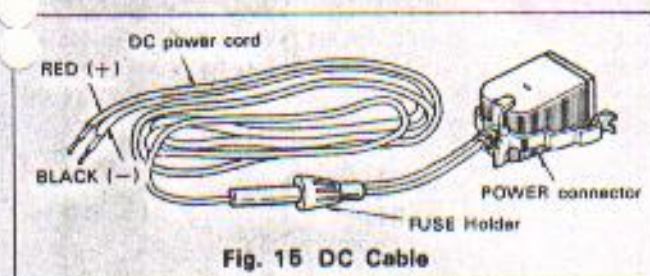

Battery Capacity

During mobile operation, the transceiver draws about 5.5A of current, so a battery having about 35AH of capacity is sufficient for proper transceiver operation. However, since the battery is given an additional load, it is advisable to use the transceiver while the car engine is operating.

Note:

To insure safe driving of car, it is recommended that the transceiver be operated in fixed channel mode.

5-16. REPEATER OPERATION

In repeater operation, A-B or B-A position of the FUNCTION SW should be used.

Referring to Page 17 5-9, set VFO A and VFO B frequency to the repeater frequencies with the specified split respectively.

For example in 2m band, set VFO A to 145,000 MHz and VFO B to 144,400 MHz. This setting means, in A-B position of the FUNCTION SW, that TS-770 reception is carried out at 145,000 MHz and TS-770 transmission at 144,400 MHz.

In this manner, the split frequency between reception and transmission becomes 600 kHz, and repeater operation can be accomplished.

With set to B-A position, the reception and the transmission frequency reverse each other.

In 70 cm band, set the two VFO frequency to each repeater frequencies with the adequate split as above.

Starting System:

Carrier controlled type. Actuate by tone controlled (tone frequency 1750 Hz).

The built-in tone oscillator operates at 1750 Hz when the TONE switch is pressed, and at the same time, a repeater call signal is automatically transmitted. Releasing the hand from the switch automatically stops the oscillator.

5-17. OSCAR OPERATION

At present, two amateur radio communication satellites (No. 7 and No. 8) are travelling along the orbit of the earth (No. 6 is not available because the battery power has been exhausted). These satellites can be used as your repeater. The TS-770 will function when used with the satellites as follows:

[OSCAR No. 7]

A mode: 2m ~ 10m Repeater up-link transmitter
B mode: 70 cm ~ 2m ... Repeater up-link transmitter
or Repeater down-link receiver

[OSCAR No. 8]

A mode: 2m ~ 10m Repeater up-link transmitter
J mode: 2m ~ 70 cm Repeater up-link transmitter
or Repeater down-link receiver

[RADIO 1,2]

2m ~ 10m Repeater up-link transmitter

Table 1 shows the link frequencies. An example of application of the TS-770 in 70 cm ~ 2m repeater operation is illustrated in Fig. 4.

OSCAR operation with the TS-770 alone where the FUNCTION switch is set to A-B and the VFO A is used as a 430 MHz band receiver and the VFO B as a 145 MHz band transmitter, is not possible because the down-link signal cannot be monitored.

In OSCAR operation, it is imperative to use a separate transmitter and receiver so that the down-link signal can be received as shown in Fig. 17. It is also necessary for you to become acquainted with some special knowledges relative to the orbit tracking of satellite, usage of beacon waves, operating manner, antenna installation, etc.

With basic knowledges, you will be able to enjoy repeater communication through the amateur satellites with little difficulty. Reference materials such as guide books and instruction books are available from market.

	OSCAR No. 7		OSCAR No. 8		RADIO No. 1, 2 (2m-10m)
	A mode (2m-10m)	B mode * (70cm-2m)	A mode (2m-10m)	J mode * (2m-70cm)	
Up-link frequency	145.65 to 145.95	432.125 to 432.175	145.85 to 145.95	145.9 to 146.0	145.88 to 145.92
Down-link frequency	29.40 to 29.50	145.975 to 145.925	29.40 to 29.50	435.1 to 435.2	29.360 to 29.400
Beacon frequency	29.502	145.972	29.402	435.097	29.400

* B or J mode are received by LSB mode.

Table 3.

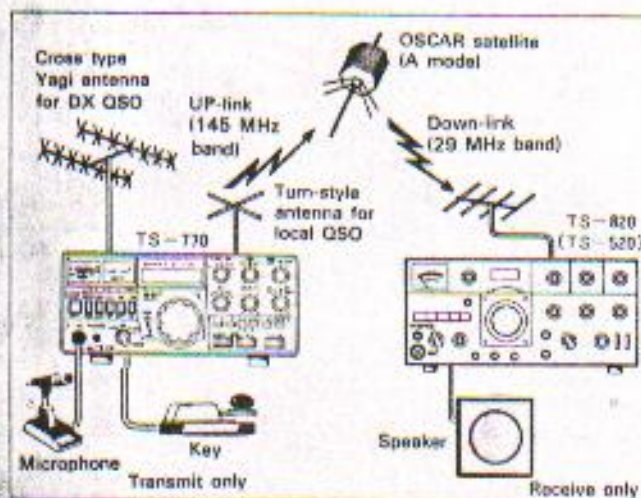

Fig. 16 Example of OSCAR Operation

5-18. AUX SOCKET

This socket is used for connecting the supplied DIN connector to supply the following voltages to external equipment.

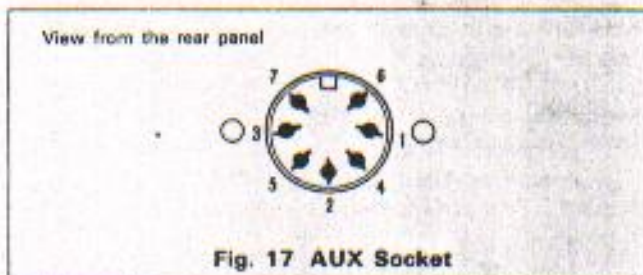

Fig. 17 AUX Socket

Terminal No.	Voltage symbol	Application
1	NC	Open terminal
2	E43	8V DC 10 mA (430 MHz)
3	ELC	External ALC input terminal
4	E14	8V DC 10 mA (144 MHz)
5	ERL	12V DC 10 mA at transmit
6	ATX	Used only for adjustments of transceiver.
7	SS	External standby terminal Transmitter operates when earthed.

Table 4.

The AUX socket is used for connection to a linear amplifier, receiver booster or external standby unit. When using care should be taken so that each of the load currents at the terminals 2, 4 and 5 will not exceed 10 mA, as otherwise the transceiver may be damaged.

SECTION 6. OPTIONAL ACCESSORIES

For more enjoyable operation of your TS-770, the following accessories are available from your dealer as options:

● Communication Microphone

The following microphones are available. Choose one that best suits the purpose of use.

MC-20 — Miniature type handy dynamic microphone with PTT switch. The impedance is 500 ohms.

MC-30S — Handy dynamic microphone with noise cancelling PTT switch specifically designed for mobile operation. The impedance is 500 ohms.

MC-50 — Uni-directional dynamic microphone for fixed station operation. It provides excellent performance when used in noisy locations or for VOX operation. This microphone has a PTT switch with lock mechanism. The output impedance is selected in 2 steps, 50 kilo-ohms and 600 ohms (600 ohms for TS-770).

● Communication External Speaker

SP-70 — This speaker provides clear, natural tone with the use of a high-cut cone, best suited for communication

use.

● Communication Headphones

HS-4 — Specifically designed with consideration given to the shape of ear pads, materials and weight to insure many hours of fatigueless listening. The impedance is 8 ohms.

● High Class Communication Headphones

HS-5 — The most ideal headphones with "open air" type ear pads to eliminate pressure to the head and ears and to provide natural tone. The open air type ear pads can be readily replaced with the pressure type ones.

● Ham Clock

HC-2 — Twenty-four hour system clock with a time chart to check the time over the world at a glance. It operates for more than one year with a single UM-1 dry battery.

● External Power Battery Case

BU-1 — Back-up power battery case used to keep the memory circuit operating when AC power is not available. Use five UM-3 dry batteries or six nickel-cadmium batteries. (Battery charger available for nickel-cadmium batteries.)

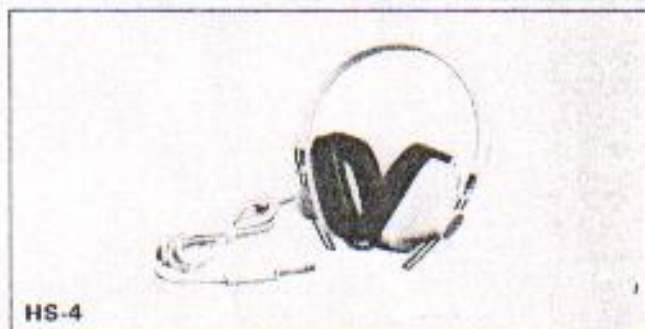

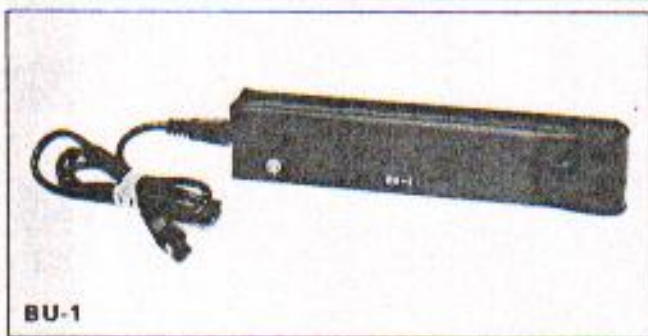

SECTION 7. TROUBLE SHOOTING

The following symptoms shown are not faults. Carefully read and check the following. If a symptom remains after the corresponding countermeasure has been taken, contact our service division.

SYMPTOMS	CAUSE	COUNTERMEASURE
Frequency indication error during SCAN	If FUNCTION switch is switched to VFO : A from Fix with SCAN switch ON, indication may be erroneous because SCAN is carried out by means of VFO : B.	Turn SCAN switch OFF. To continue SCAN using VFO : A, turn SCAN switch ON again.
No receiver noise from speaker in FM mode.	Squelch circuit is ON.	Turn SQUELCH control counterclockwise.
Transceiver is connected to antenna, but no signal is received, while "S" meter pointer remains deflected.	RF GAIN control is set too low.	Turn RF GAIN control fully clockwise.
Even in the absence of signal, "S" meter pointer remains deflected.	RF GAIN control is set too low.	Turn RF GAIN control fully clockwise.
SSB signal is being received but speaker	Transceiver is set for opposite side band	Set MODE switch to LSB or USB.
RIT control inoperative.	RIT switch is OFF.	Set RIT switch to ON (indication of digital display remains the same).
There is a frequency shift between transmission and reception.	RIT control is not in "0" position while RIT knob is ON.	Set RIT switch to ON, or set RIT control to "0" position.
Noise blanker circuit is not fully effective in suppressing noise.	<ol style="list-style-type: none"> 1. Strong signal exists close to the operating frequency. 2. Some interfering noise similar to SSB signal in waveform is coming from a nearby source (such as a high frequency welder or corona discharge device) 	
No RF power. RF power is too low (FM).	LOW switch is in LOW position.	Set LOW switch to HIGH position.
No output in SSB mode.	<ol style="list-style-type: none"> 1. Incorrect connection of microphone jack or microphone plug. 2. Turn SSB MIC control clockwise. 	<ol style="list-style-type: none"> 1. Connect correctly following the instructions.
SSB MIC control is in MIN position.		
Insufficient modulation in FM mode.	FM MIC GAIN control is in MIN position.	Turn FM MIC GAIN control clockwise.
No side tone in CW mode.	Side tone control is in MIN position.	Adjust the side tone control.
/VOX will not work.	<ol style="list-style-type: none"> 1. VOX GAIN control is OFF. 2. VOX GAIN control is in MIN position. 	<ol style="list-style-type: none"> 1. Turn VOX GAIN control clockwise to ON. 2. Turn VOX GAIN control clockwise for proper action.
VOX is activated by speaker sound.	Improper ANTI VOX control adjustment.	Turn clockwise and adjust ANTI VOX control in the case.
Turning VFO will not change digital display frequency.	FIX CH knob is in fixed channel position.	Set FIX CH knob to VFO.
Stored data is cleared causing the micro-computer to misoperate when car engine is started.	Car battery is wornout, or battery voltage is too low due to a large current drain causing the back-up function to be released.	Use the external back-up power battery case to protect the memory circuit from misoperation.

SECTION 8. CIRCUIT ARRANGEMENT

9-1. BLOCK DIAGRAM

Block diagram of the TS-770 is shown on page 26.

Each circuit is of modular design and wired on circuit board. The transmit and receive systems are as follows:

Receiver (SSB, FM) — Double superheterodyne

Transmitter SSB — Filter type balanced modulation

Transmitter FM — Variable reactance direct modulation

Transmitter CW — Block bias keying system

Cautions:

The TS-770 digital VFO generates frequencies in 20 Hz steps, so the frequency shifts from 0 to 20, 40, 60, 80 in 20 Hz steps. On the other hand, the frequency stored in a fixed channel is the frequency to the nearest 100 Hz which is indicated on the digital display and, hence, there is maximum error of 80 Hz when an operating frequency is stored.

Example:

Operating frequency:

144.225.1 B Freq. of 10 Hz order

(digital freq.) (not shown in digital display, but frequency shifts from 0 to 2, 4, 6, 8 ...)

Stored frequency:

144.225.1 Deviation of a maximum of ± 80 Hz

This deviation is not critical in FM operation. If it becomes a problem during CW or SSB operation, turn the RIT switch to ON and adjust the RIT knob to your party's station.

BLOCK DIAGRAM

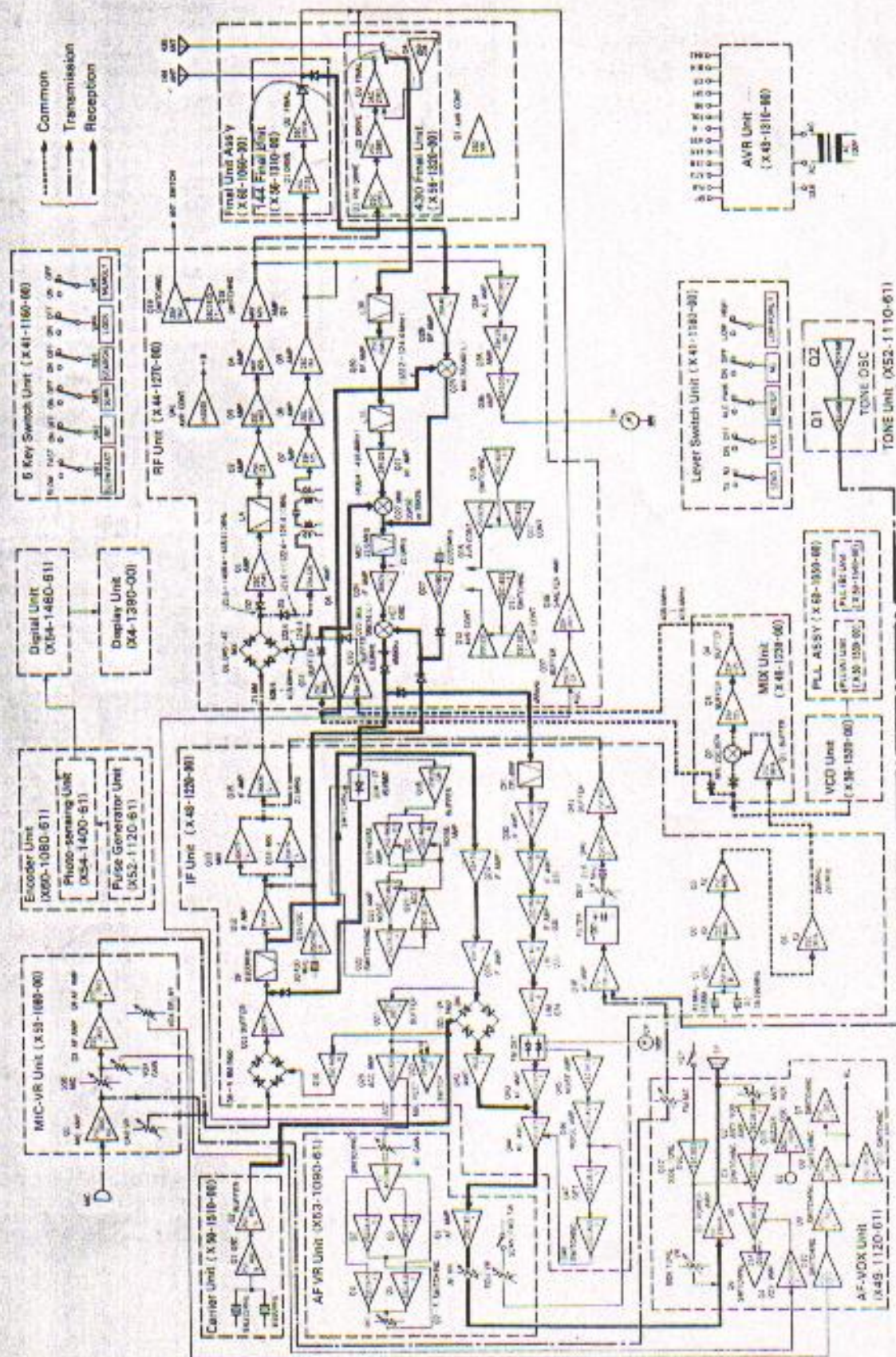

AGRAM (IF Unit) (TONE Unit)

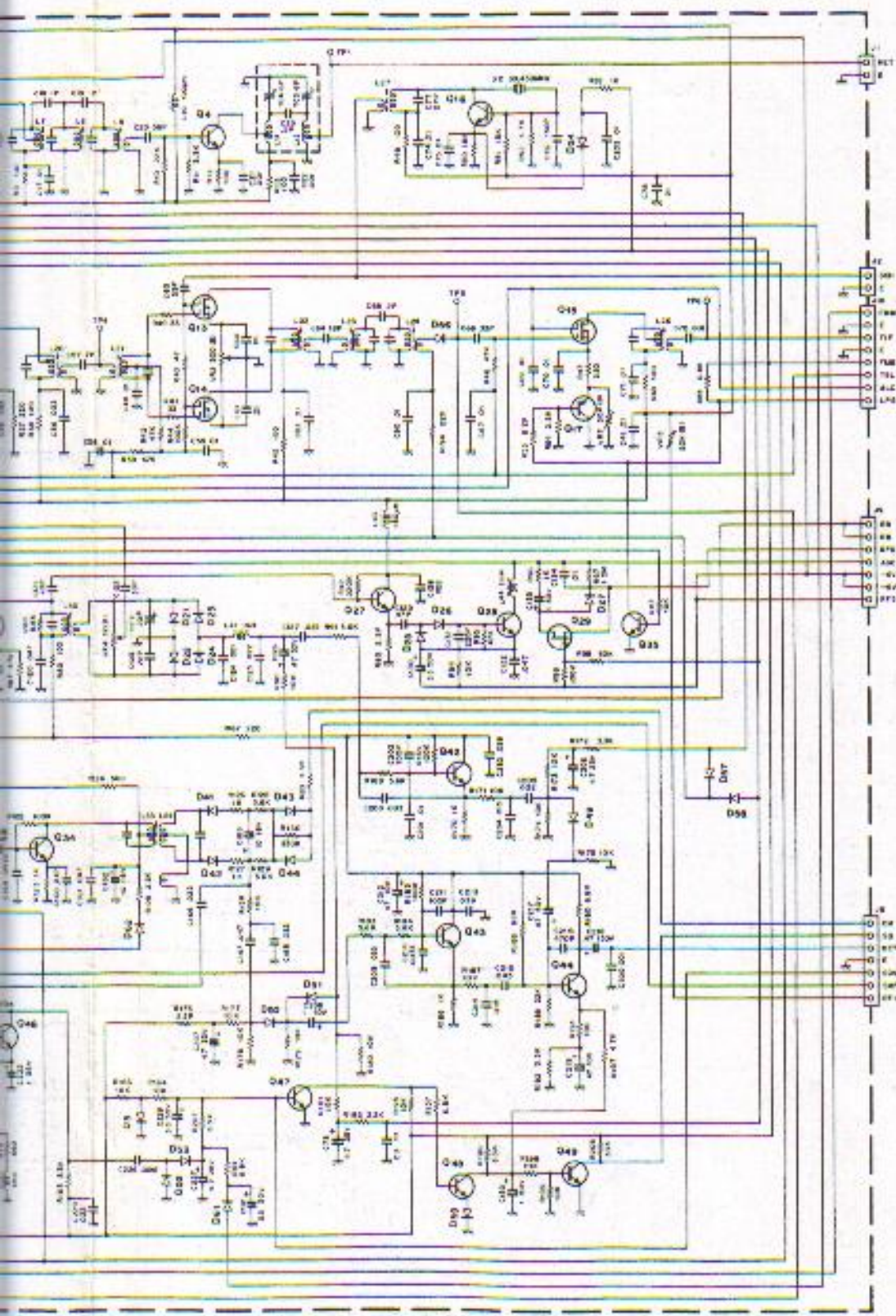

- Q1,10,16,19,20,21,30,31,32,33,34,36
37,40,41,50
: 2SC460 (BI)
- Q2,3 : 2SC388A
- Q4 : 2SC387A
- Q5,6,7,8,9,22,23,27,28,39,42,43,44
45,46,47,48,49
: 2SC1815 (Y)
- Q11,13,14,15,24,26,12
: 3SK74 (LI)
- Q17 : 2SA1015 (Y)
- Q18 : 2SK19 (GR)
- Q29 : 2SK30A (OI)
- Q38 : TA7061AP
- D1,2,5,10,11,12,13,14,15,16,17,30,31
32,33
: 1S1587
- D3 : 1S1212
- D4,27,28,29,34,35,49,37,38,39,40
48,50,51,54,55,56,57,58,59,62
: 1S1555
- D6,7,8,9,18,19,21,22,23,24,25,26
41,42,43,44,45,46,52,53,61
: 1N60
- D20 : MV-13
- D47 : 1S2208

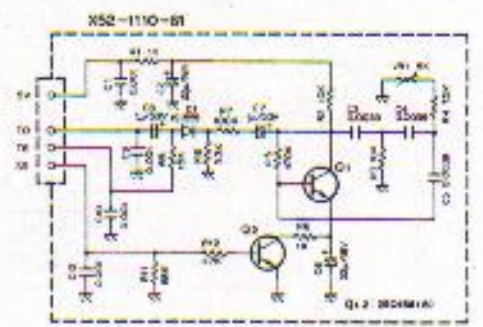

SCHEMATIC DIAGRAM

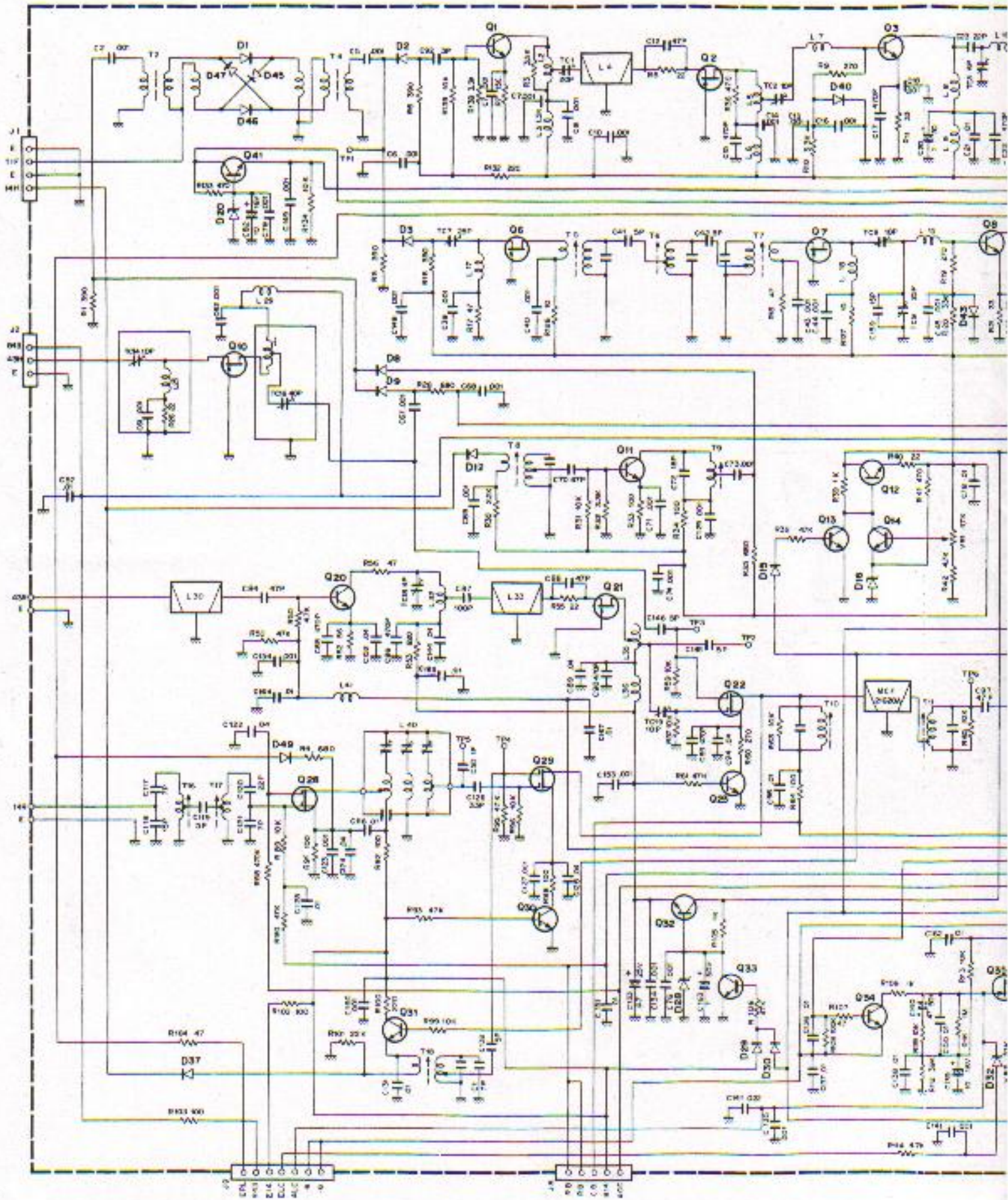

RAM (RF Unit)

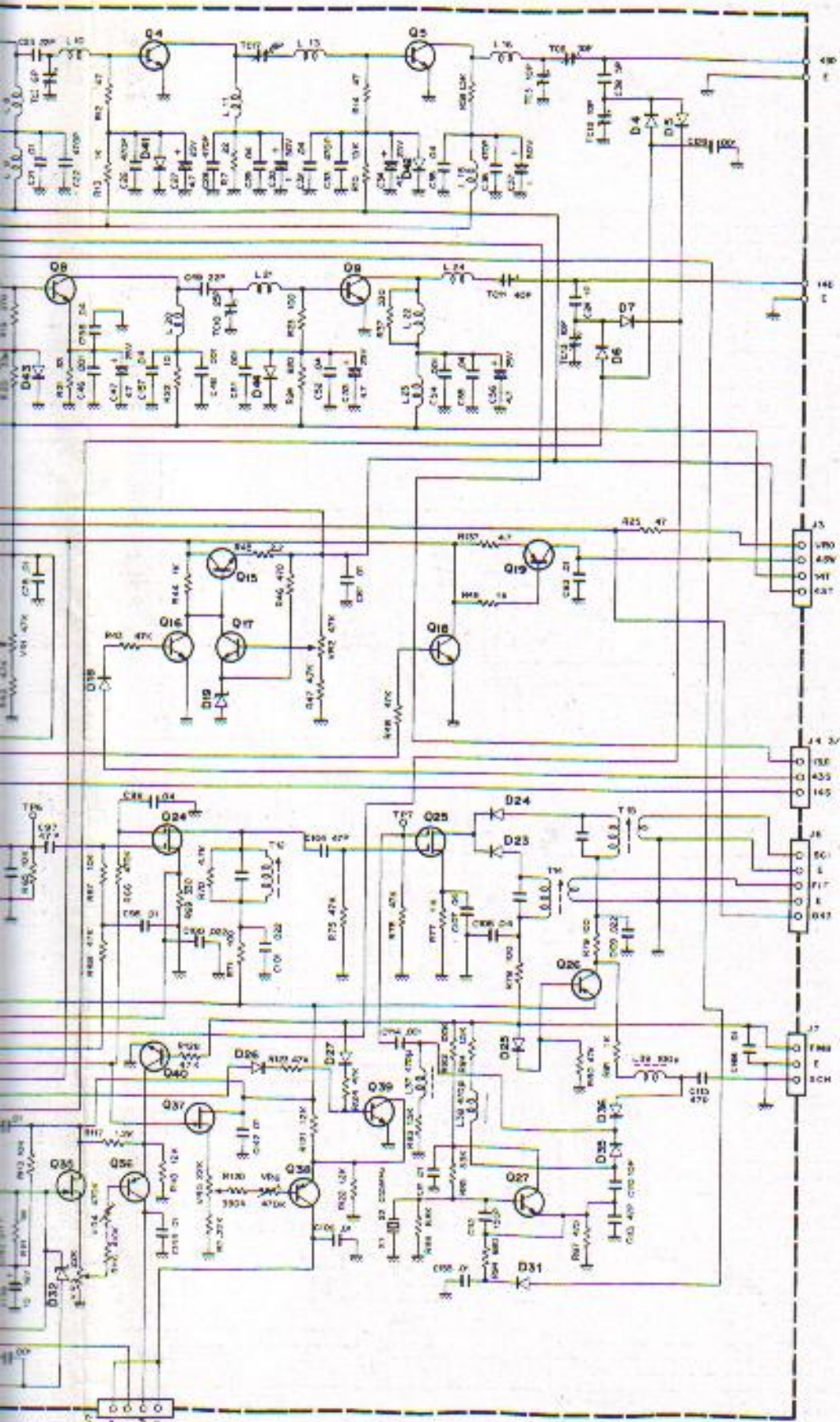

- | | |
|----------------------|------------------|
| Q2,6,7,10,21 | : 25K125 |
| Q3,8 | : 25C2407 |
| Q4,5 | : MRP629 |
| Q9 | : 25C741 |
| Q11 | : 25C387A |
| Q12,15,41 | : 25D255 |
| Q13,14,16,18,23 | |
| 30,31,32,33,34,36,40 | : 25C1815(Y) |
| Q19 | : 25A562(Y) |
| Q1,20 | : 25C2549 |
| Q22 | : 35K92 or 35K76 |
| Q24,25 | : 35K74(L) |
| Q26-36,38 | : 25A1015(Y) |
| Q27 | : 25C460(B) |
| Q28,29 | : 35K40(L) |
| Q32 | : 25C735(Y) |
| Q35,37 | : 25K19GR1 |
| D1,45-47 | : 15597 |
| D2,3,9-11 | : 152588 |
| D4-7,25 | : 1N60 |
| D6,12,23,24,35-37 | : 151587 |
| D15,18,26,27,29-31 | |
| 41,42,44,49 | : 151555 |
| D16,19,32 | : XZ060 |
| D20 | : XZ132 |
| D28 | : XZ117 |
| D40,43 | : MUI3 |

TS-770 SCHEM

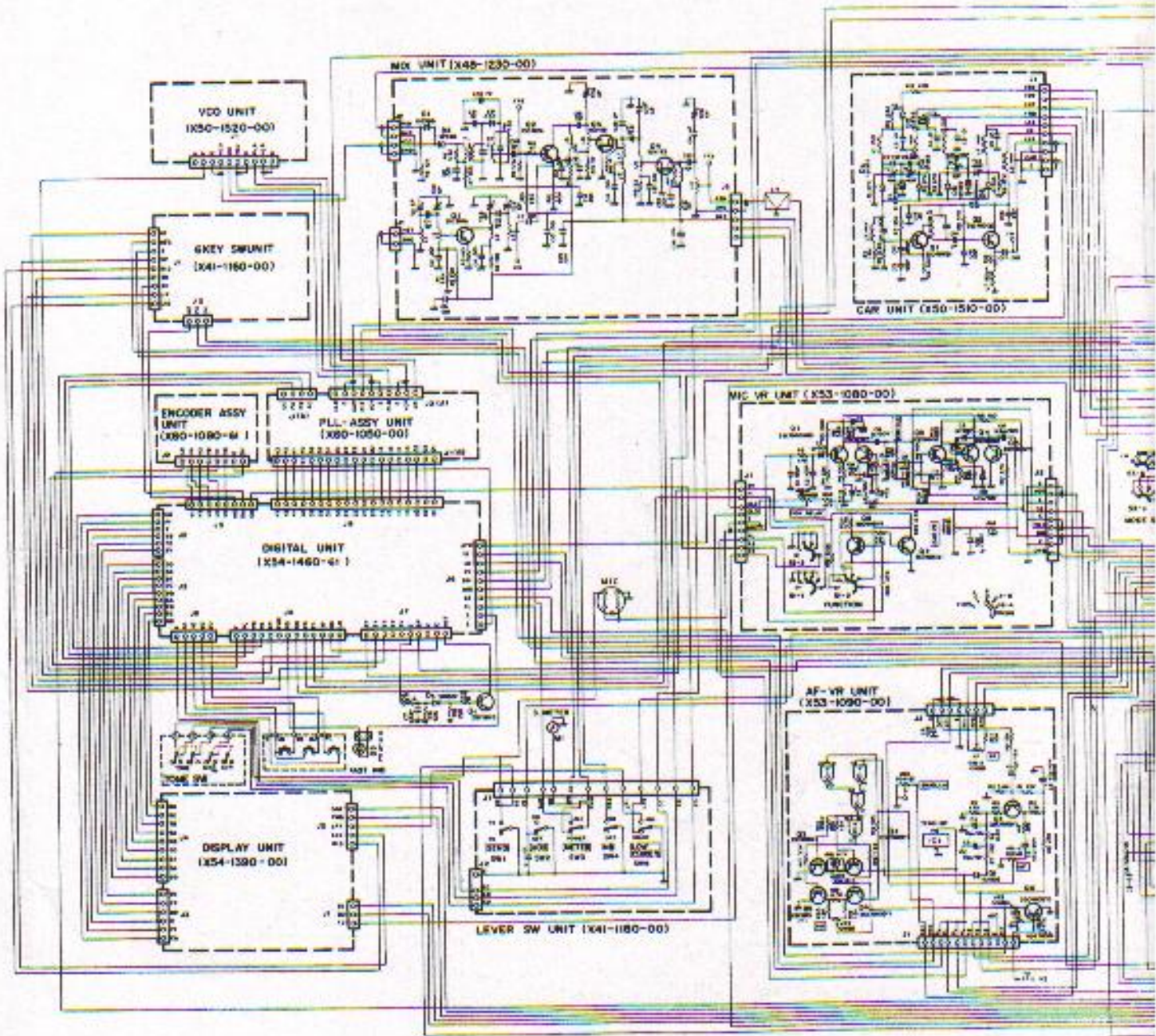

CHEMATIC DIAGRAM

The schematics and specifications are subject to change without notice for improvement.

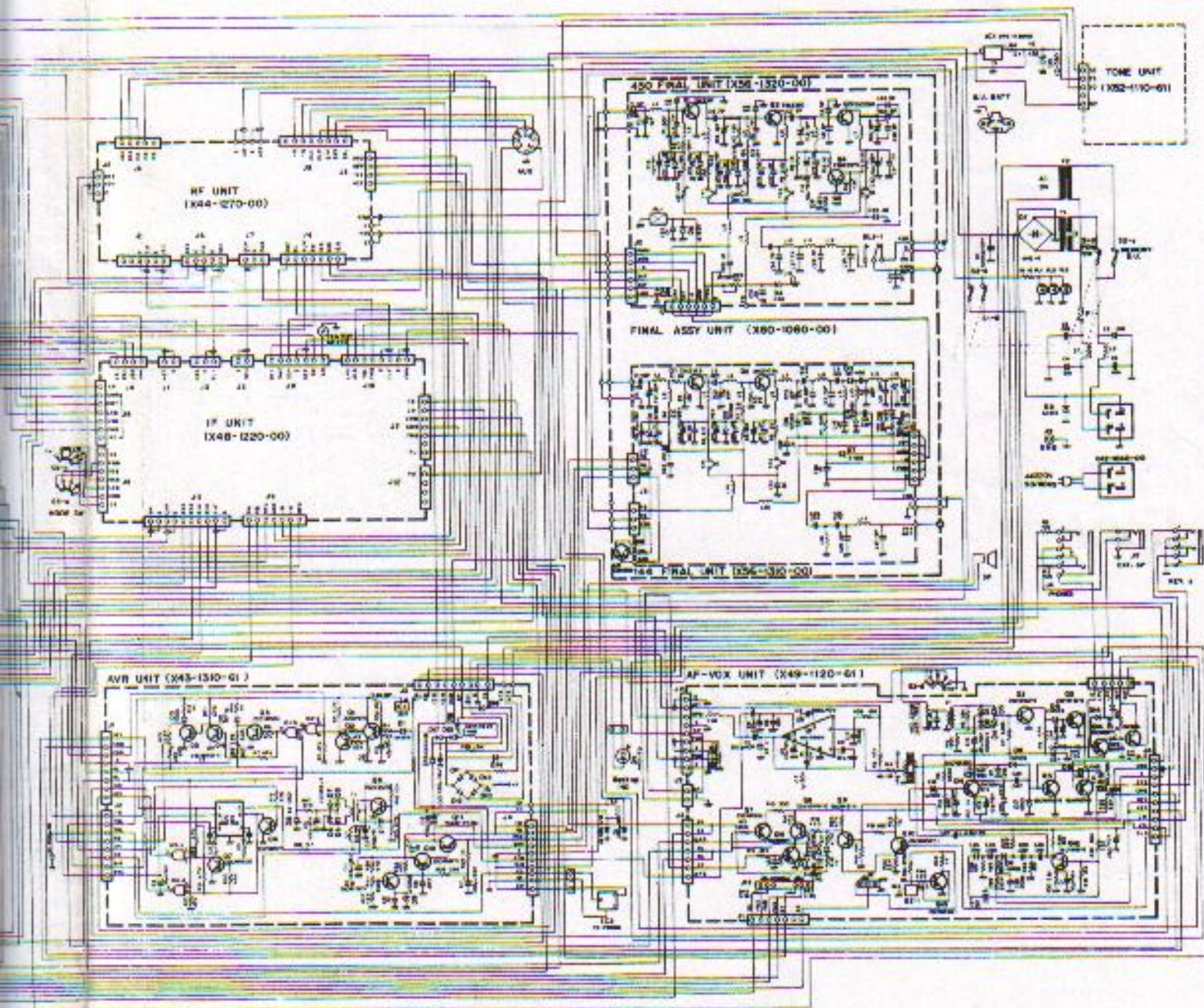

TOP & BOTTOM INTERNAL VIEWS



MIX Unit
(X43-1230-00)

PLL Unit Assy
(X-60-1050-00)

AF VR Unit
(X63-1090-61)

430 Final Unit
(156-1320-00)

MIC-VR Unit
(X63-1080-00)

RF Unit
(X44-1270-00)
(Lower side)

Display Unit
(X54-1390-00)

Digital Unit
(X54-1480-61)

AF-VOX Unit
(X49-1120-61)

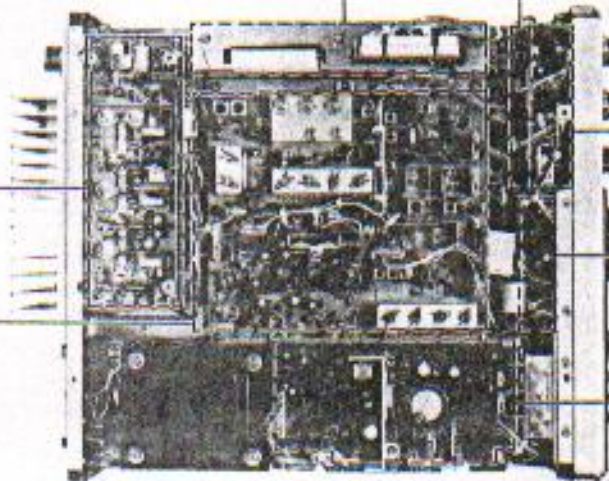

AVR Unit
(X43-1310-00)

VCO Unit
(X60-1520-00)

144 Final Unit
(X56-1310-00)

IF Unit
(X48-1220-00)

Encoder Unit
(X90-1080-61)

CAR Unit
(X-50-1510-00)

Lower Switch Unit
(X41-1180-00)

6 Key Switch Unit
(X41-1180-00)

Tone Unit
(X52-1110-61)

